



WASHINGTON  
CONVENTION CENTER

# Meeting Room Layouts

## Room 204

OPEN TO BELOW



## LEGEND

	Stacking Chair	
	8' x 30" Table	
	8' x 18" Table	
	6' x 18" Table	
	6' x 30" Table	
	72" BANQUET ROUND TABLE	
	30" COCKTAIL ROUND TABLE	
	6'X8' MEETING ROOM RISER	
	8'X8' MEETING ROOM RISER	
	3'X3' DANCE FLOOR PANELS	
	CONGRESSIONAL LECTERN STANDARD	
	STATESMAN LECTERN (VIP)	
	CONGRESSIONAL LECTERN (ADA)	
	CONGRESSIONAL LECTERN (TABLE-TOP)	
	ADA LIFT	
	ADA RAMP	
	STEP UNIT (2)	
	STEP UNIT (3)	
	STEP UNIT (5)	
	TELEPHONE	
	FIRE EXIT	

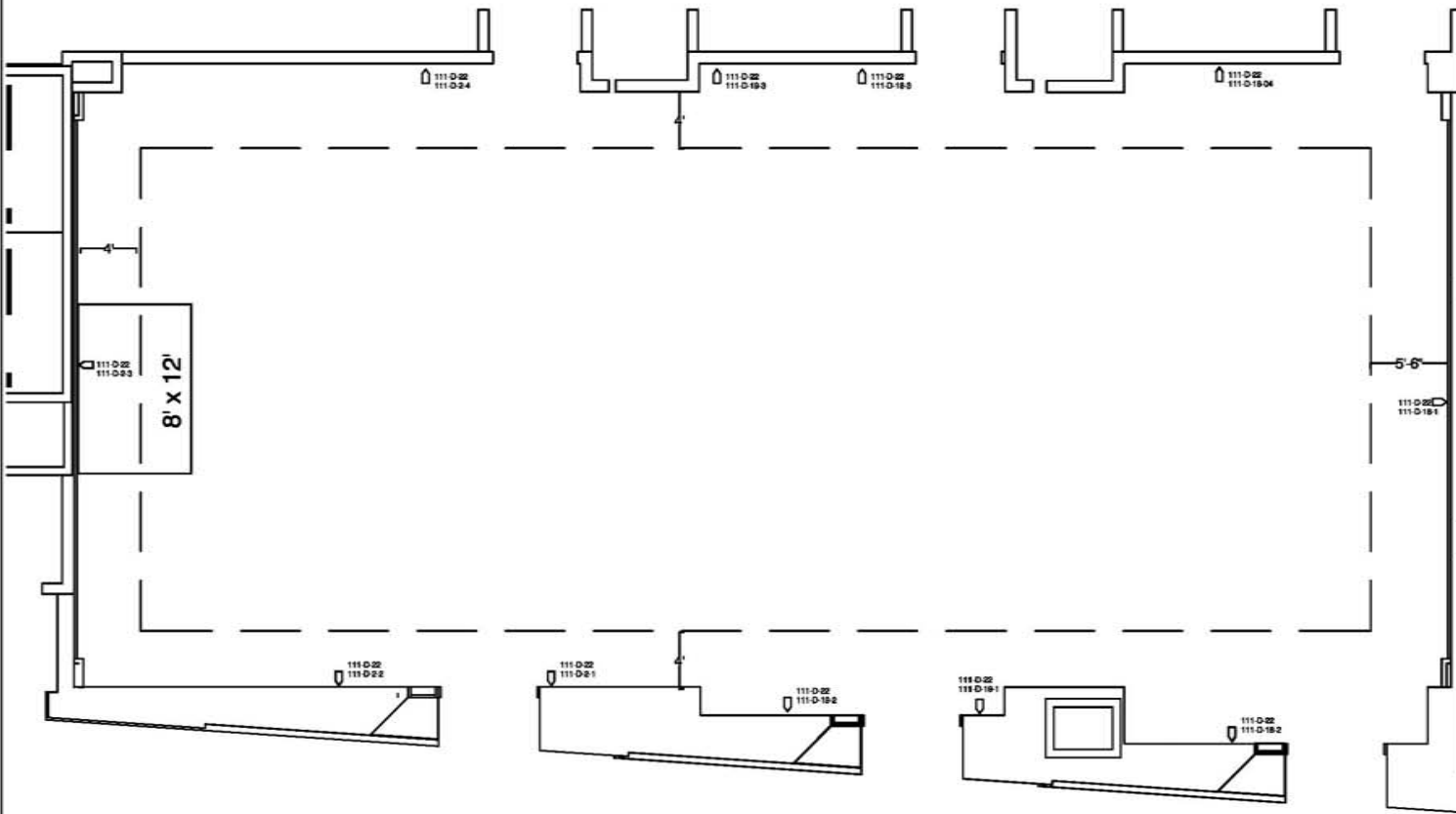

Standard Set Includes 8' x 12' Stage



WASHINGTON  
CONVENTION CENTER

Meeting Room: 204 ABC

Banquet Capacity: 210

## LEGEND

	Stacking Chair	
	8' x 30" Table	
	8' x 18" Table	
	6' x 18" Table	
	6' x 30" Table	
	72" BANQUET ROUND TABLE	
	30" COCKTAIL ROUND TABLE	
	6'X8' MEETING ROOM RISER	
	8'X8' MEETING ROOM RISER	
	3'X3' DANCE FLOOR PANELS	
	CONGRESSIONAL LECTERN STANDARD	
	STATESMAN LECTERN (VIP)	
	CONGRESSIONAL LECTERN (ADA)	
	CONGRESSIONAL LECTERN (TABLE-TOP)	
	ADA LIFT	
	ADA RAMP	
	STEP UNIT (2)	
	STEP UNIT (3)	
	STEP UNIT (5)	
	TELEPHONE	
	FIRE EXIT	

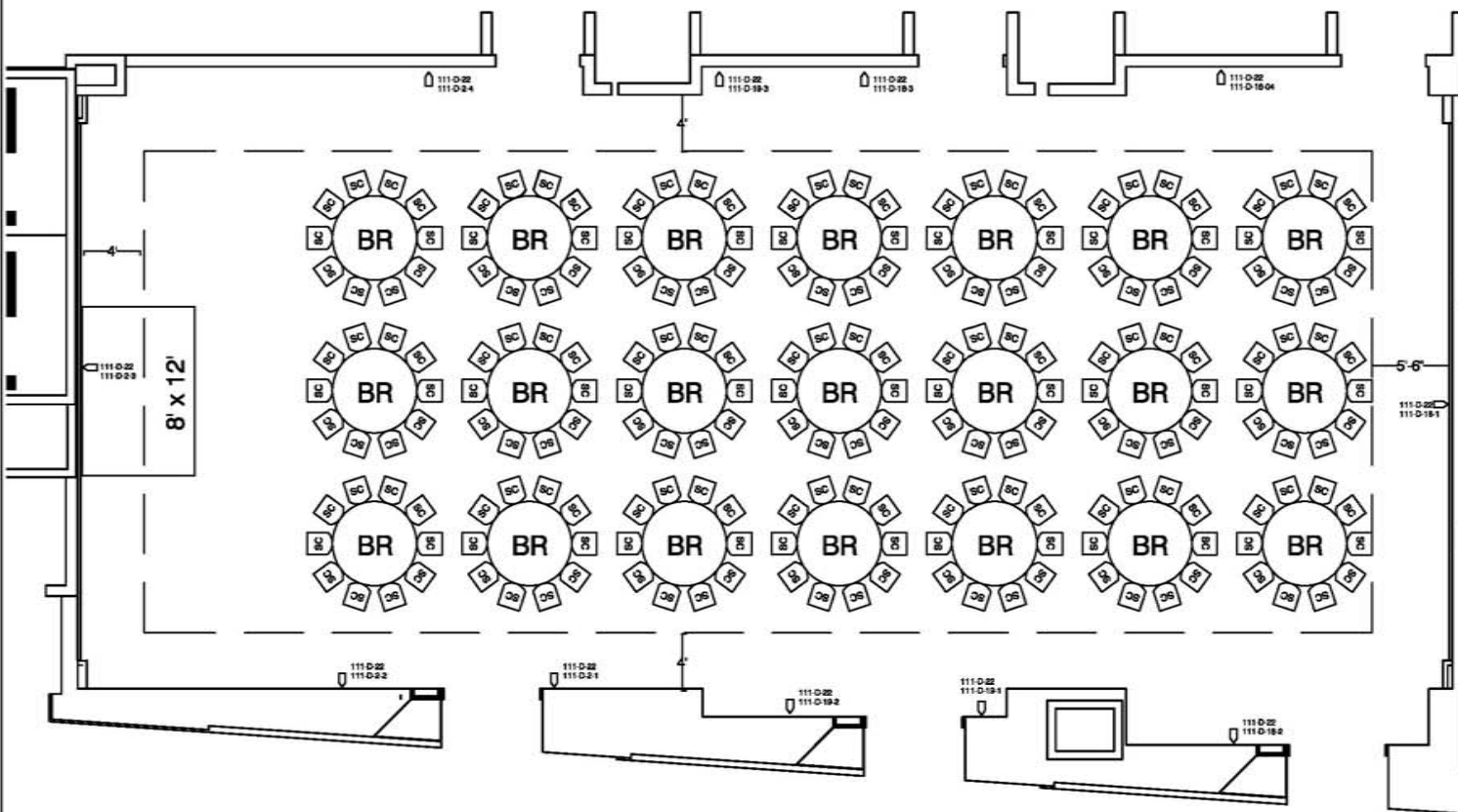



WASHINGTON  
CONVENTION CENTER

Meeting Room: 204 ABC

Theater Capacity: 450

## LEGEND

	Stacking Chair	
	8' x 30" Table	
	8' x 18" Table	
	6' x 18" Table	
	6' x 30" Table	
	72" BANQUET ROUND TABLE	
	30" COCKTAIL ROUND TABLE	
	6'X8' MEETING ROOM RISER	
	8'X8' MEETING ROOM RISER	
	3'X3' DANCE FLOOR PANELS	
	CONGRESSIONAL LECTERN STANDARD	
	STATESMAN LECTERN (VIP)	
	CONGRESSIONAL LECTERN (ADA)	
	CONGRESSIONAL LECTERN (TABLE-TOP)	
	ADA LIFT	
	ADA RAMP	
	STEP UNIT (2)	
	STEP UNIT (3)	
	STEP UNIT (5)	
	TELEPHONE	
	FIRE EXIT	

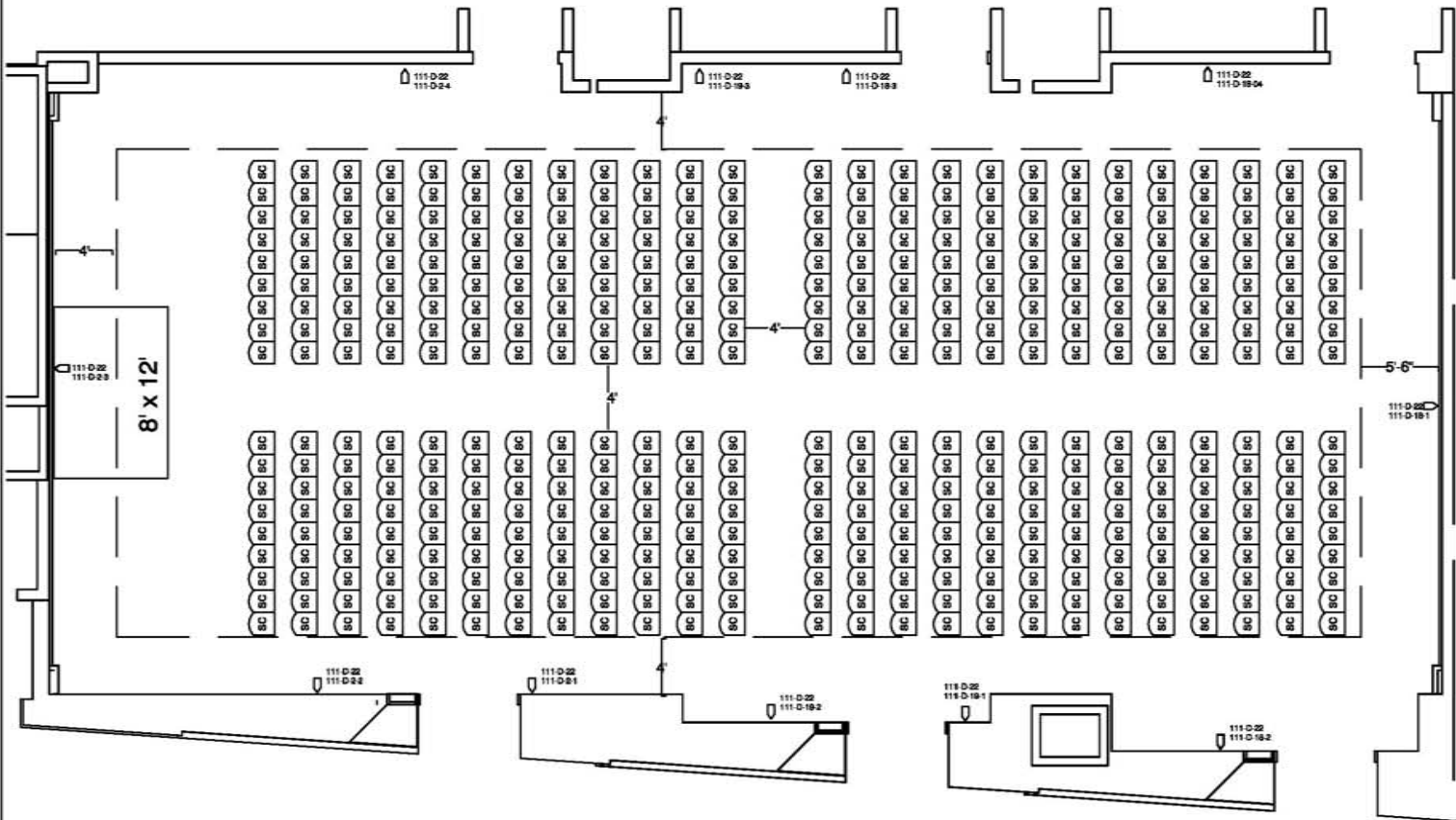

Standard Set Includes 8' x 12' Stage



WASHINGTON  
CONVENTION CENTER

Meeting Room: 204 ABC  
Classroom Capacity: 165

### LEGEND

	Stacking Chair	
	8' x 30" Table	
	8' x 18" Table	
	6' x 18" Table	
	6' x 30" Table	
	72" BANQUET ROUND TABLE	
	30" COCKTAIL ROUND TABLE	
	6'X8' MEETING ROOM RISER	
	8'X8' MEETING ROOM RISER	
	3'X3' DANCE FLOOR PANELS	
	CONGRESSIONAL LECTERN STANDARD	
	STATESMAN LECTERN (VIP)	
	CONGRESSIONAL LECTERN (ADA)	
	CONGRESSIONAL LECTERN (TABLE-TOP)	
	ADA LIFT	
	ADA RAMP	
	STEP UNIT (2)	
	STEP UNIT (3)	
	STEP UNIT (5)	
	TELEPHONE	
	FIRE EXIT	

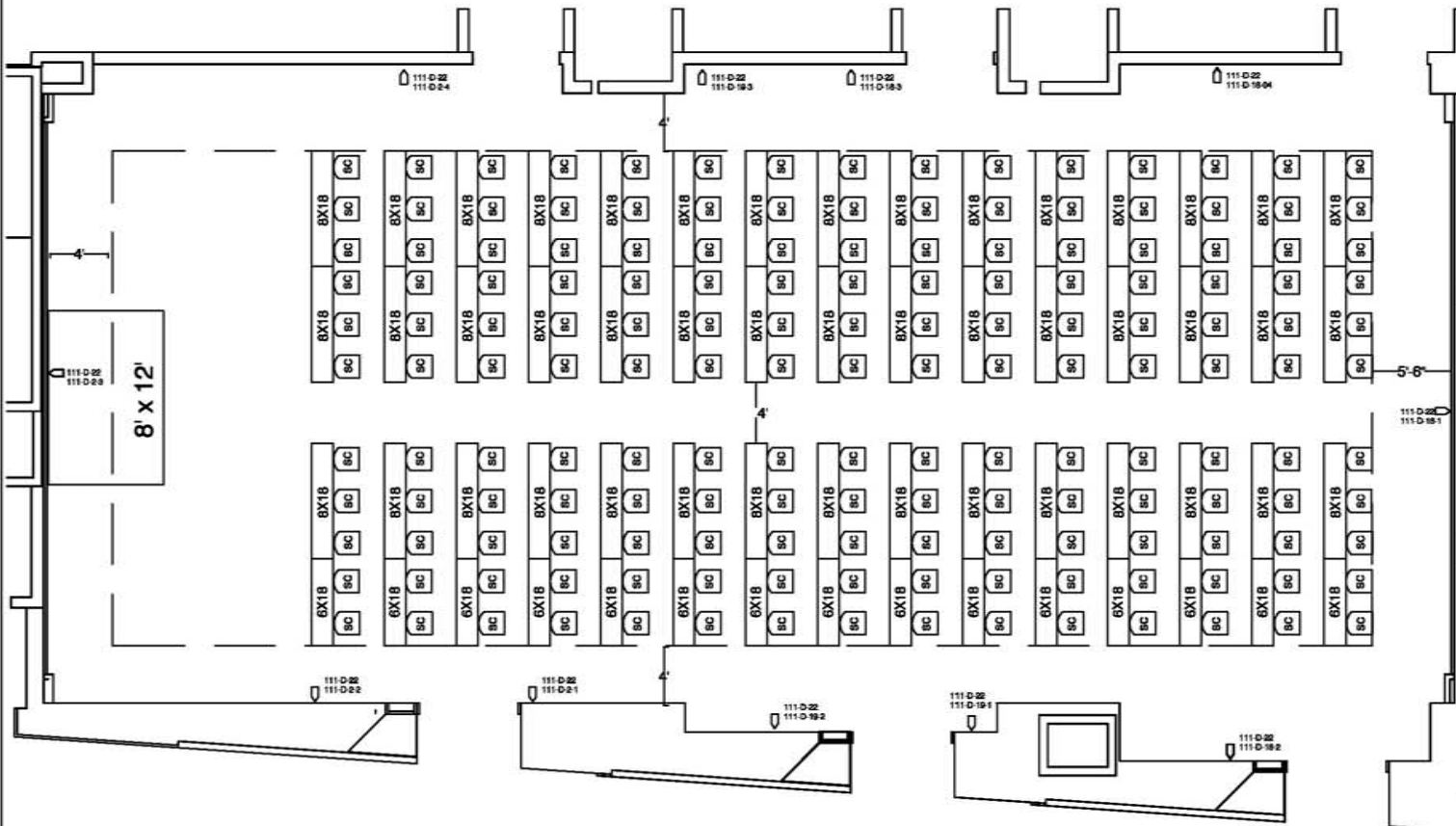

Standard Set Includes 8' x 12' Stage

Drawing as of 6/24/06



WASHINGTON  
CONVENTION CENTER

Meeting Room: 204 AB

## LEGEND

	Stacking Chair	
	8' x 30" Table	
	8' x 18" Table	
	6' x 18" Table	
	6' x 30" Table	
	72" BANQUET ROUND TABLE	
	30" COCKTAIL ROUND TABLE	
	6'X8' MEETING ROOM RISER	
	8'X8' MEETING ROOM RISER	
	3'X3' DANCE FLOOR PANELS	
	CONGRESSIONAL LECTERN STANDARD	
	STATESMAN LECTERN (VIP)	
	CONGRESSIONAL LECTERN (ADA)	
	CONGRESSIONAL LECTERN (TABLE-TOP)	
	ADA LIFT	
	ADA RAMP	
	STEP UNIT (2)	
	STEP UNIT (3)	
	STEP UNIT (5)	
	TELEPHONE	
	FIRE EXIT	

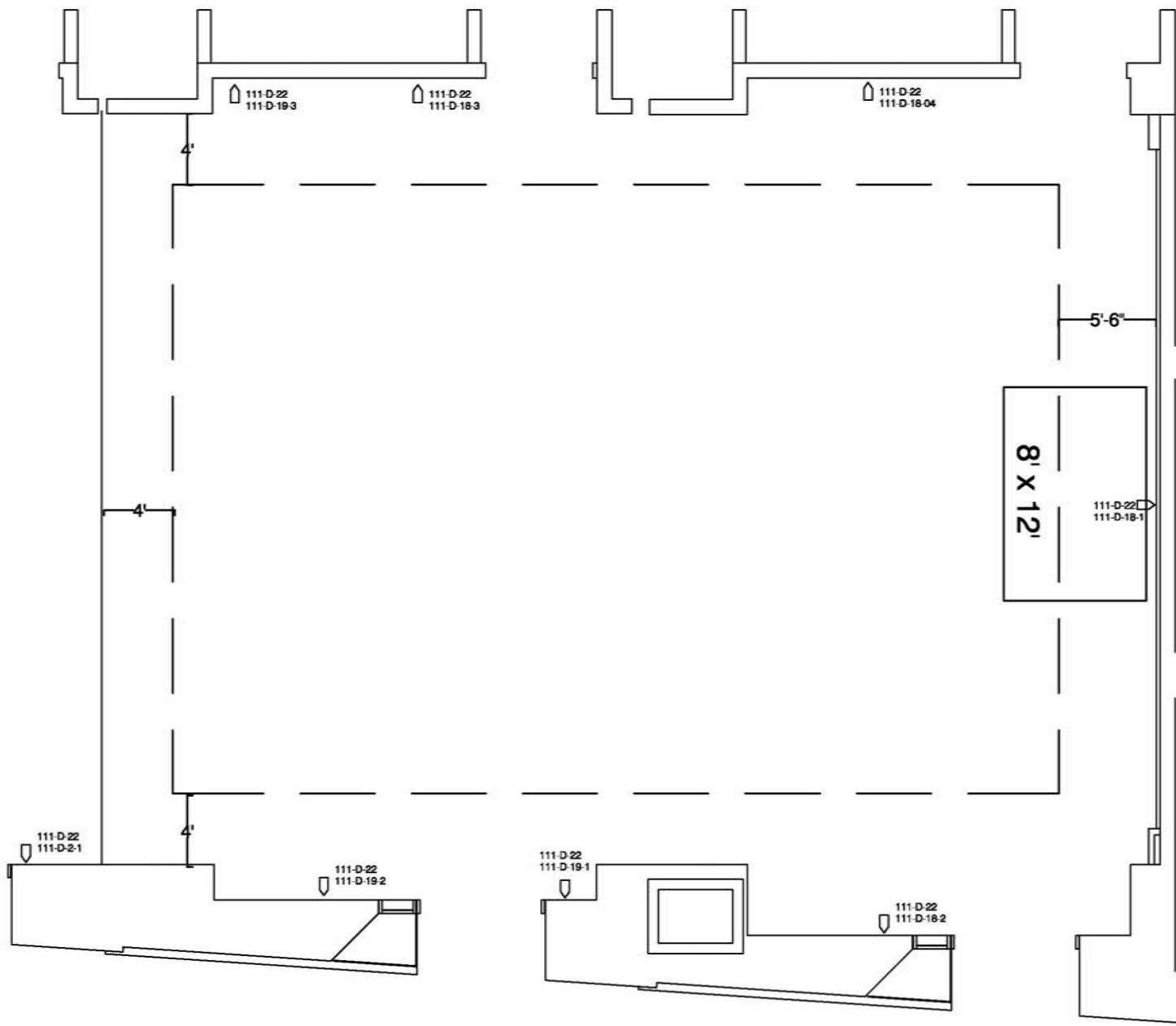

**Standard Set Includes 8' x 12' Stage**

Drawing as of 6/24/06



WASHINGTON  
CONVENTION CENTER

Meeting Room: 204 AB

Banquet Capacity: 120

## LEGEND

	Stacking Chair	
	8' x 30" Table	
	8' x 18" Table	
	6' x 18" Table	
	6' x 30" Table	
	72" BANQUET ROUND TABLE	
	30" COCKTAIL ROUND TABLE	
	6'X8' MEETING ROOM RISER	
	8'X8' MEETING ROOM RISER	
	3'X3' DANCE FLOOR PANELS	
	CONGRESSIONAL LECTERN STANDARD	
	STATESMAN LECTERN (VIP)	
	CONGRESSIONAL LECTERN (ADA)	
	CONGRESSIONAL LECTERN (TABLE-TOP)	
	ADA LIFT	
	ADA RAMP	
	STEP UNIT (2)	
	STEP UNIT (3)	
	STEP UNIT (5)	
	TELEPHONE	
	FIRE EXIT	

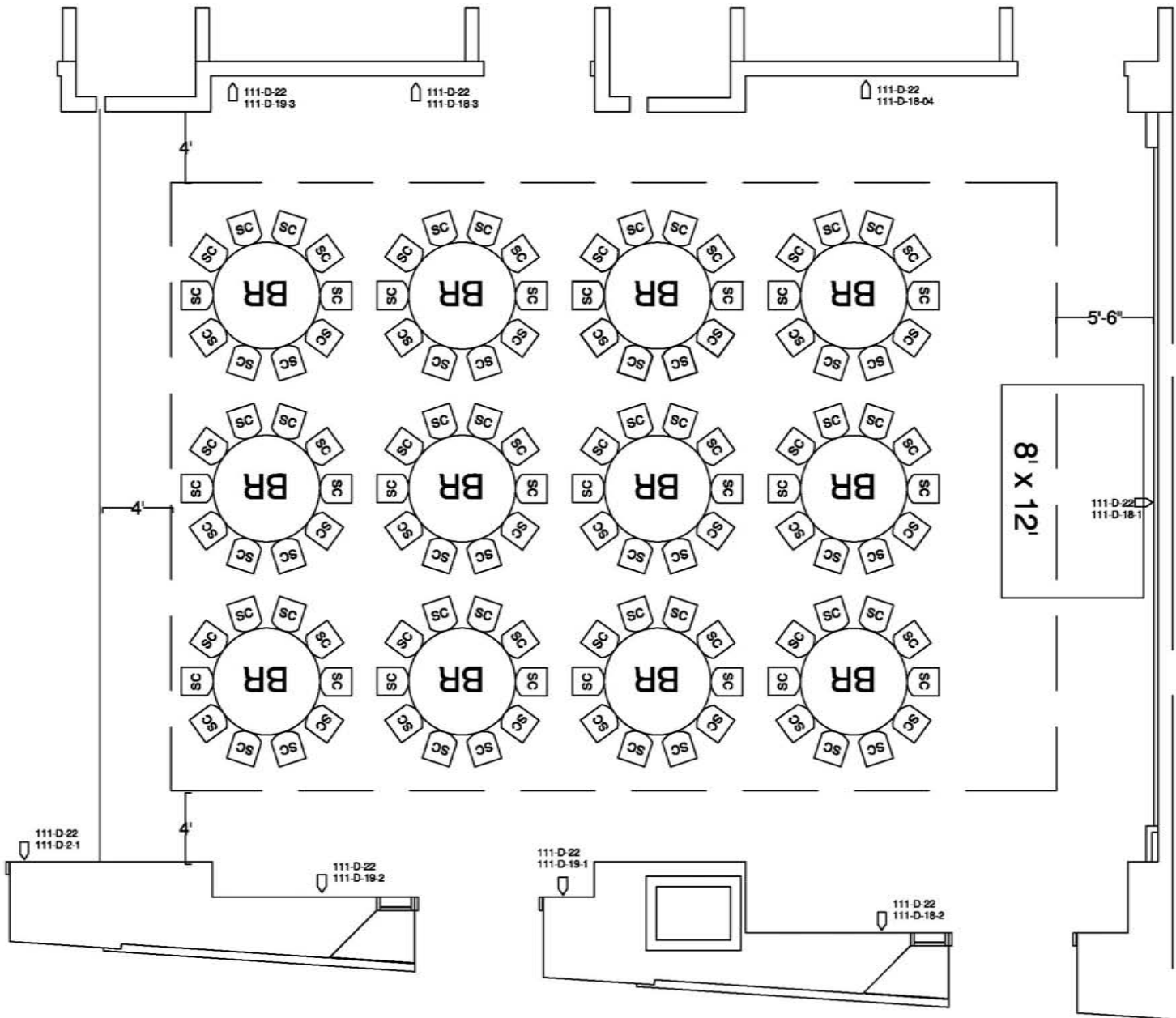

**Standard Set Includes 8' x 12' Stage**



WASHINGTON  
CONVENTION CENTER

Meeting Room: 204 AB  
Theater Capacity: 252

### LEGEND

	Stacking Chair	
	8' x 30" Table	
	8' x 18" Table	
	6' x 18" Table	
	6' x 30" Table	
	72" BANQUET ROUND TABLE	
	30" COCKTAIL ROUND TABLE	
	6'X8' MEETING ROOM RISER	
	8'X8' MEETING ROOM RISER	
	3'X3' DANCE FLOOR PANELS	
	CONGRESSIONAL LECTERN STANDARD	
	STATESMAN LECTERN (VIP)	
	CONGRESSIONAL LECTERN (ADA)	
	CONGRESSIONAL LECTERN (TABLE-TOP)	
	ADA LIFT	
	ADA RAMP	
	STEP UNIT (2)	
	STEP UNIT (3)	
	STEP UNIT (5)	
	TELEPHONE	
	FIRE EXIT	

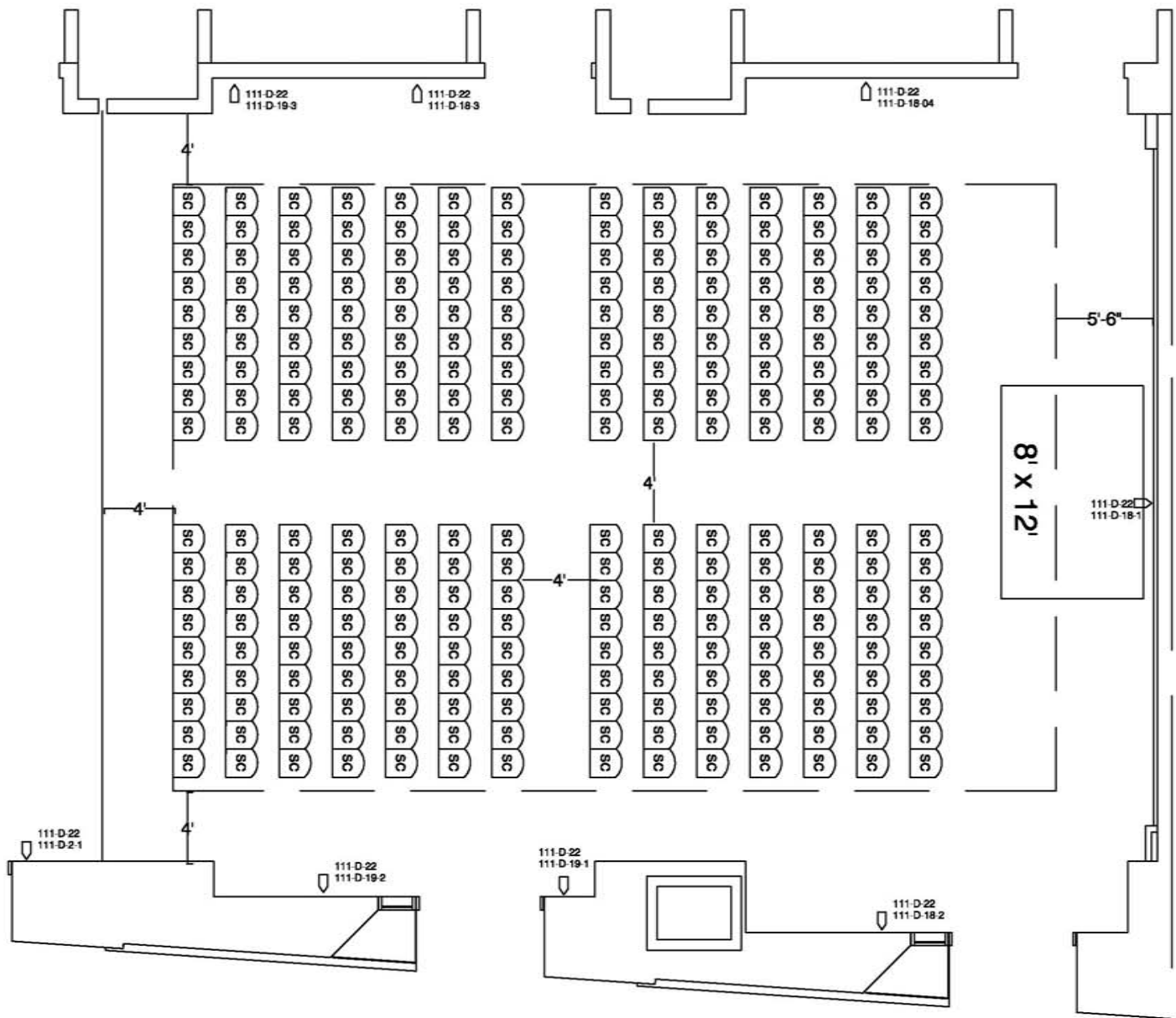

Standard Set Includes 8' x 12' Stage





WASHINGTON  
CONVENTION CENTER

Meeting Room: 204 AB  
Classroom Capacity: 88

### LEGEND

	Stacking Chair	
	8' x 30" Table	
	8' x 18" Table	
	6' x 18" Table	
	6' x 30" Table	
	72" BANQUET ROUND TABLE	
	30" COCKTAIL ROUND TABLE	
	6'X8' MEETING ROOM RISER	
	8'X8' MEETING ROOM RISER	
	3'X3' DANCE FLOOR PANELS	
	CONGRESSIONAL LECTERN STANDARD	
	STATESMAN LECTERN (VIP)	
	CONGRESSIONAL LECTERN (ADA)	
	CONGRESSIONAL LECTERN (TABLE-TOP)	
	ADA LIFT	
	ADA RAMP	
	STEP UNIT (2)	
	STEP UNIT (3)	
	STEP UNIT (5)	
	TELEPHONE	
	FIRE EXIT	

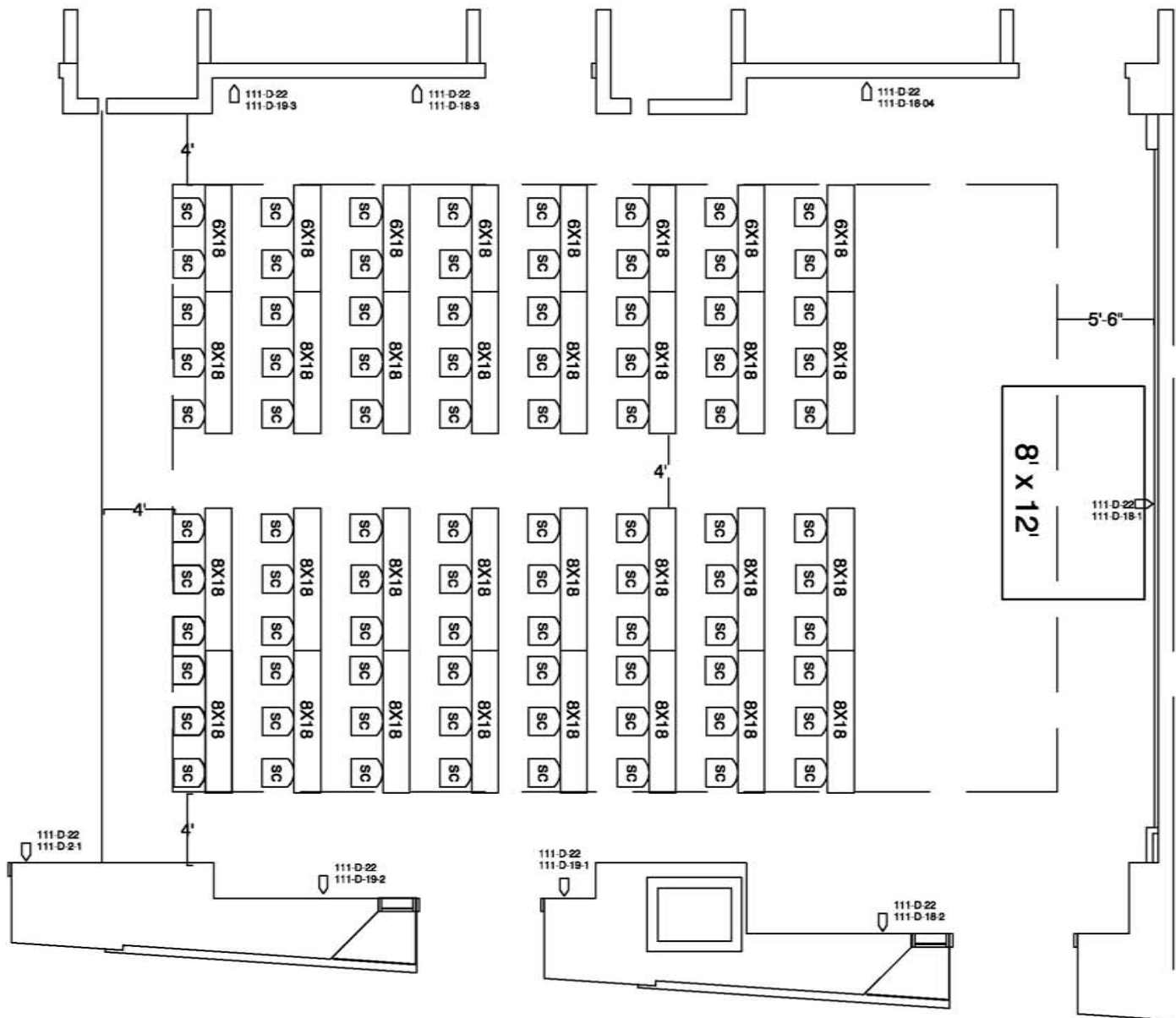

Standard Set Includes 8' x 12' Stage

Drawing as of 6/24/06



WASHINGTON  
CONVENTION CENTER

Meeting Room: 204 BC

## LEGEND

	Stacking Chair	
	8' x 30" Table	
	8' x 18" Table	
	6' x 18" Table	
	6' x 30" Table	
	72" BANQUET ROUND TABLE	
	30" COCKTAIL ROUND TABLE	
	6'X8' MEETING ROOM RISER	
	8'X8' MEETING ROOM RISER	
	3'X3' DANCE FLOOR PANELS	
	CONGRESSIONAL LECTERN STANDARD	
	STATESMAN LECTERN (VIP)	
	CONGRESSIONAL LECTERN (ADA)	
	CONGRESSIONAL LECTERN (TABLE-TOP)	
	ADA LIFT	
	ADA RAMP	
	STEP UNIT (2)	
	STEP UNIT (3)	
	STEP UNIT (5)	
	TELEPHONE	
	FIRE EXIT	

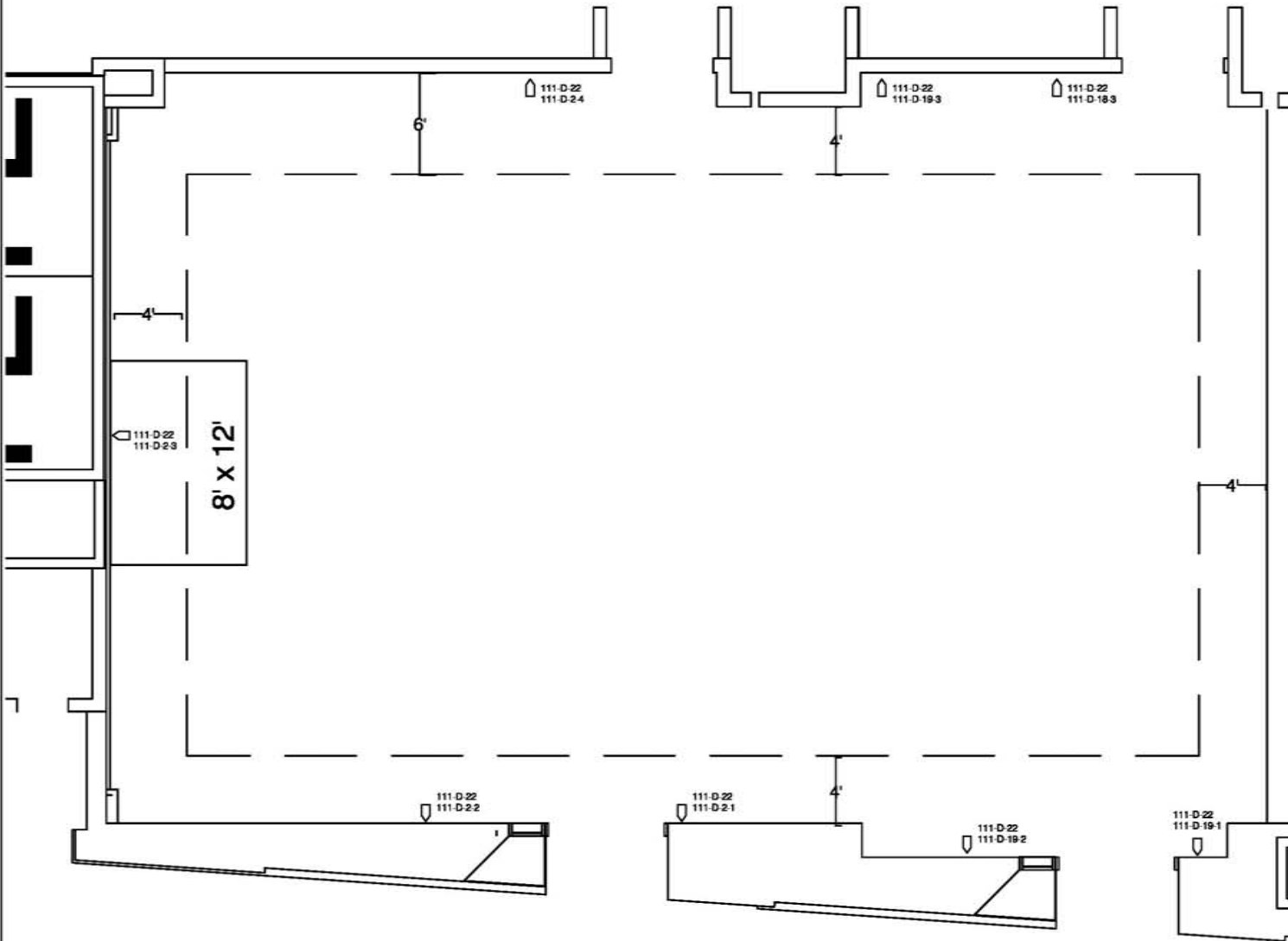

Standard Set Includes 8' x 12' Stage



WASHINGTON  
CONVENTION CENTER

Meeting Room: 204 BC

Banquet Capacity: 150

## LEGEND

	Stacking Chair	
	8' x 30" Table	
	8' x 18" Table	
	6' x 18" Table	
	6' x 30" Table	
	72" BANQUET ROUND TABLE	
	30" COCKTAIL ROUND TABLE	
	6'X8' MEETING ROOM RISER	
	8'X8' MEETING ROOM RISER	
	3'X3' DANCE FLOOR PANELS	
	CONGRESSIONAL LECTERN STANDARD	
	STATESMAN LECTERN (VIP)	
	CONGRESSIONAL LECTERN (ADA)	
	CONGRESSIONAL LECTERN (TABLE-TOP)	
	ADA LIFT	
	ADA RAMP	
	STEP UNIT (2)	
	STEP UNIT (3)	
	STEP UNIT (5)	
	TELEPHONE	
	FIRE EXIT	

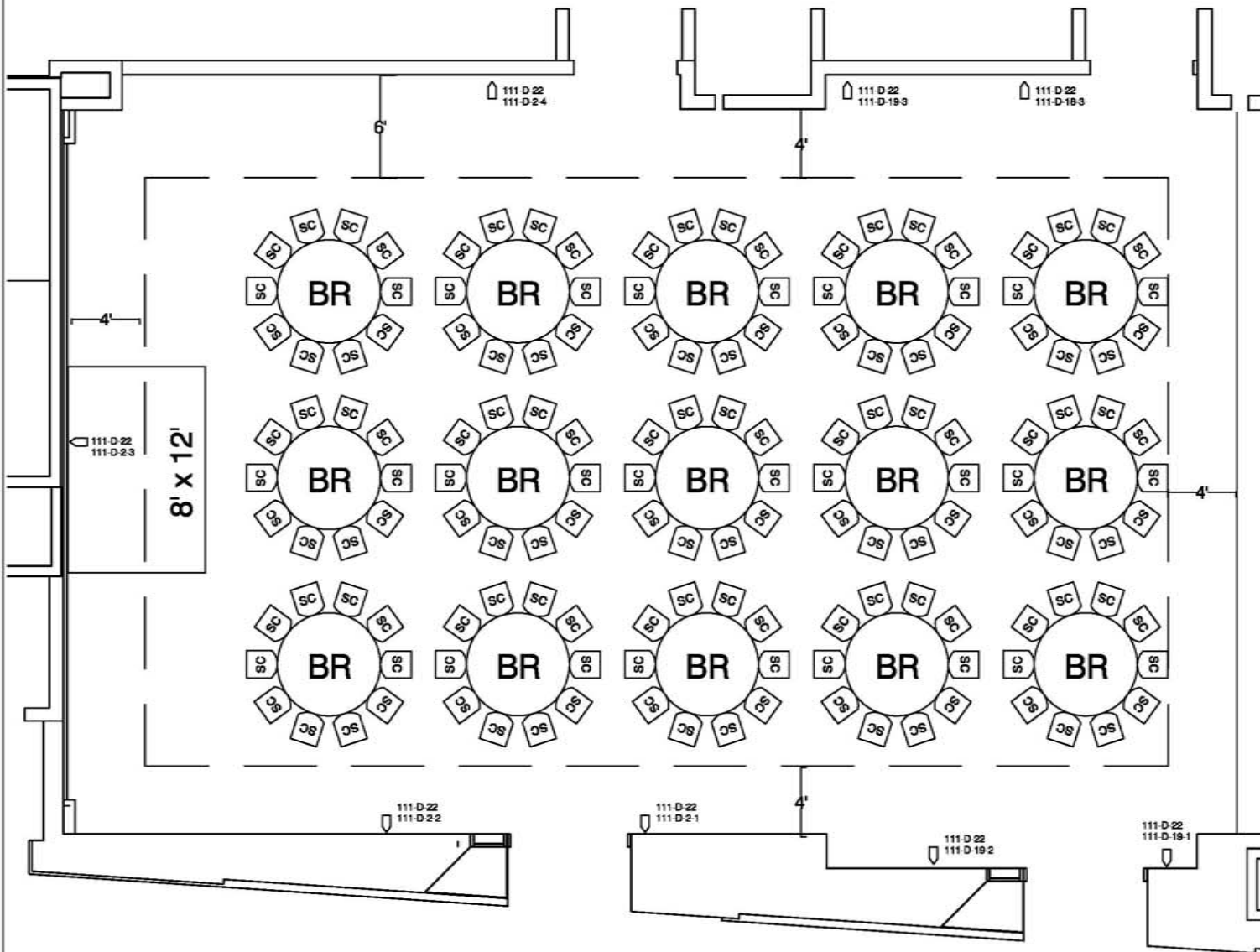

**Standard Set Includes 8' x 12' Stage**



WASHINGTON  
CONVENTION CENTER

Meeting Room: 204 BC  
Theater Capacity: 306

### LEGEND

	Stacking Chair	
	8' x 30" Table	
	8' x 18" Table	
	6' x 18" Table	
	6' x 30" Table	
	72" BANQUET ROUND TABLE	
	30" COCKTAIL ROUND TABLE	
	6'X8' MEETING ROOM RISER	
	8'X8' MEETING ROOM RISER	
	3'X3' DANCE FLOOR PANELS	
	CONGRESSIONAL LECTERN STANDARD	
	STATESMAN LECTERN (VIP)	
	CONGRESSIONAL LECTERN (ADA)	
	CONGRESSIONAL LECTERN (TABLE-TOP)	
	ADA LIFT	
	ADA RAMP	
	STEP UNIT (2)	
	STEP UNIT (3)	
	STEP UNIT (5)	
	TELEPHONE	
	FIRE EXIT	

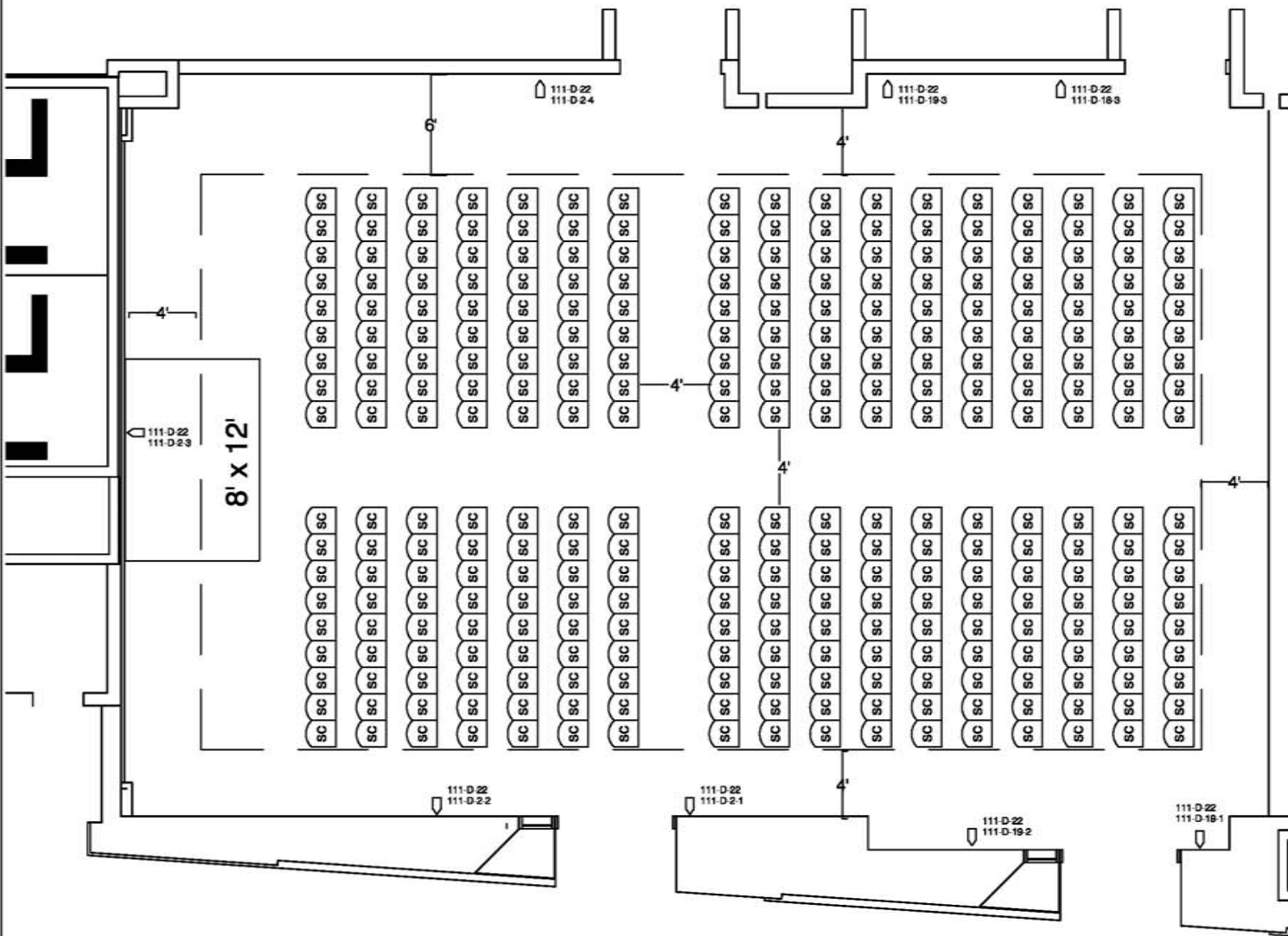

Standard Set Includes 8' x 12' Stage



Meeting Room: 204 BC  
Classroom Capacity: 110

### LEGEND

	Stacking Chair	
	8' x 30" Table	
	8' x 18" Table	
	6' x 18" Table	
	6' x 30" Table	
	72" BANQUET ROUND TABLE	
	30" COCKTAIL ROUND TABLE	
	6'X8' MEETING ROOM RISER	
	8'X8' MEETING ROOM RISER	
	3'X3' DANCE FLOOR PANELS	
	CONGRESSIONAL LECTERN STANDARD	
	STATESMAN LECTERN (VIP)	
	CONGRESSIONAL LECTERN (ADA)	
	CONGRESSIONAL LECTERN (TABLE-TOP)	
	ADA LIFT	
	ADA RAMP	
	STEP UNIT (2)	
	STEP UNIT (3)	
	STEP UNIT (5)	
	TELEPHONE	
	FIRE EXIT	

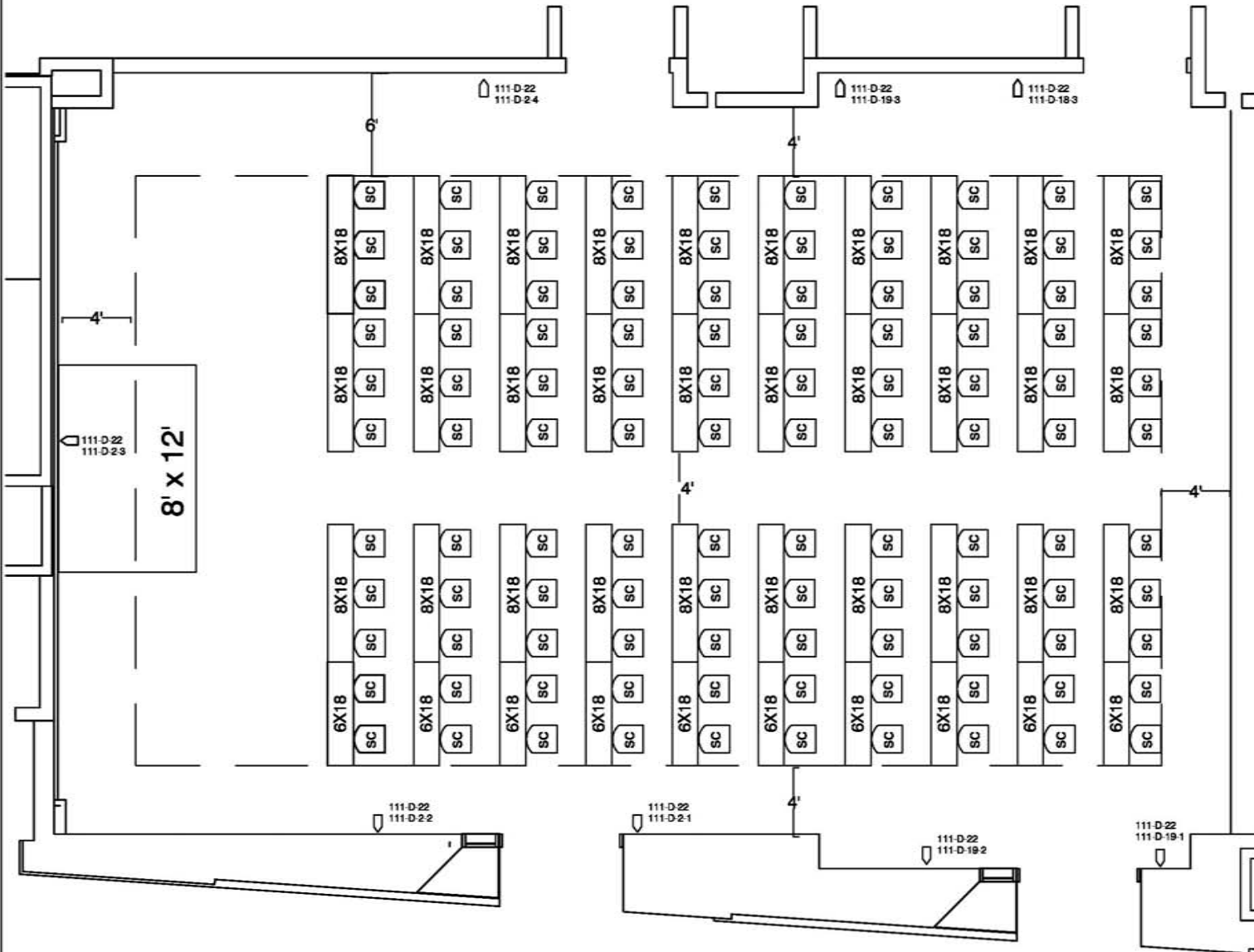

Standard Set Includes 8' x 12' Stage

Drawing as of 6/24/06

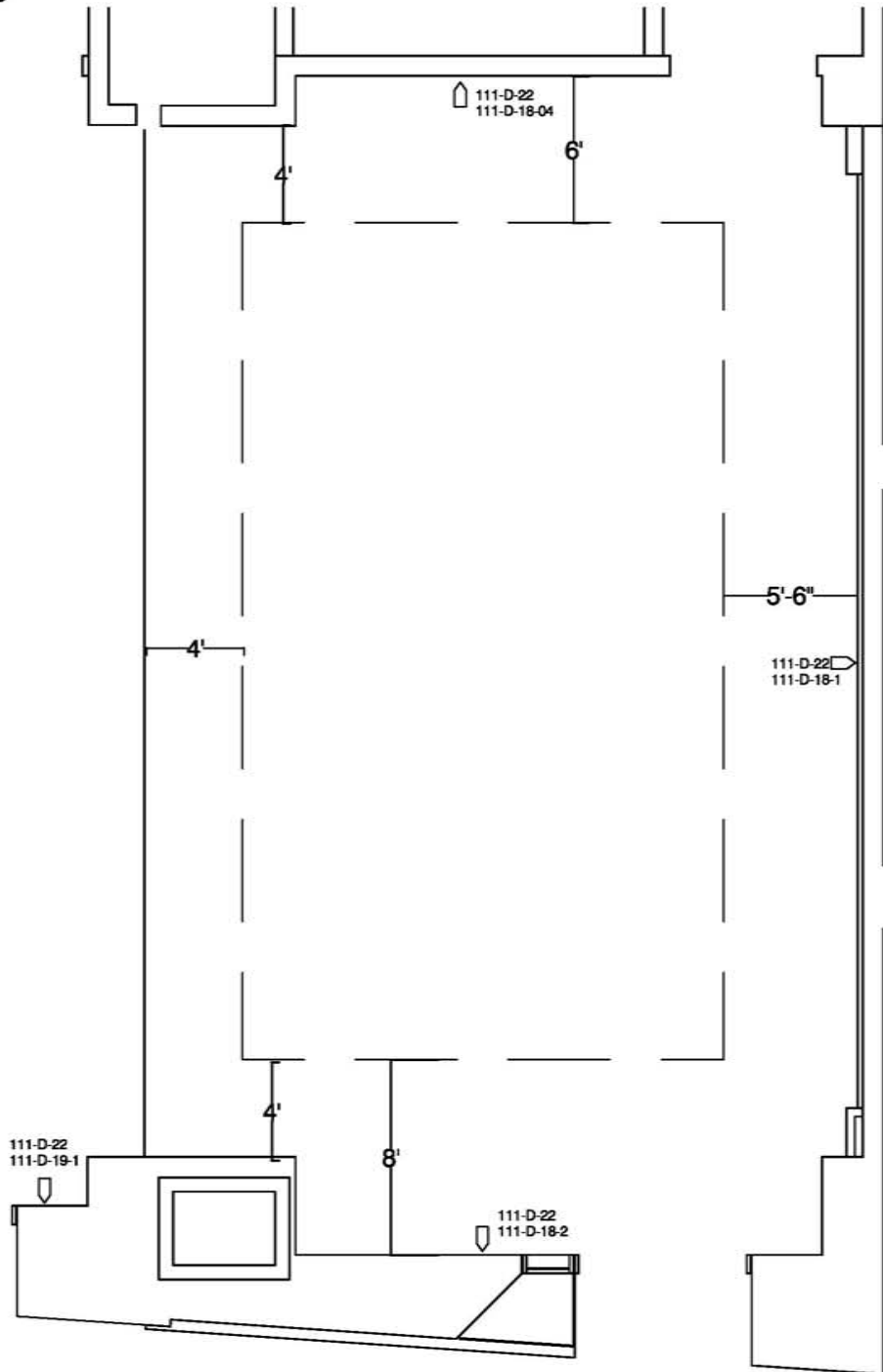

This Layout Does Not Allow Room For a Head Table  
Eliminate One Row of Tables To Place a Head Table



WASHINGTON  
CONVENTION CENTER

Meeting Room: 204 A

## LEGEND

	Stacking Chair	
	8' x 30" Table	
	8' x 18" Table	
	6' x 18" Table	
	6' x 30" Table	
	72" BANQUET ROUND TABLE	
	30" COCKTAIL ROUND TABLE	
	6'X8' MEETING ROOM RISER	
	8'X8' MEETING ROOM RISER	
	3'X3' DANCE FLOOR PANELS	
	CONGRESSIONAL LECTERN STANDARD	
	STATESMAN LECTERN (VIP)	
	CONGRESSIONAL LECTERN (ADA)	
	CONGRESSIONAL LECTERN (TABLE-TOP)	
	ADA LIFT	
	ADA RAMP	
	STEP UNIT (2)	
	STEP UNIT (3)	
	STEP UNIT (5)	
	TELEPHONE	
	FIRE EXIT	

Drawing as of 6/24/06

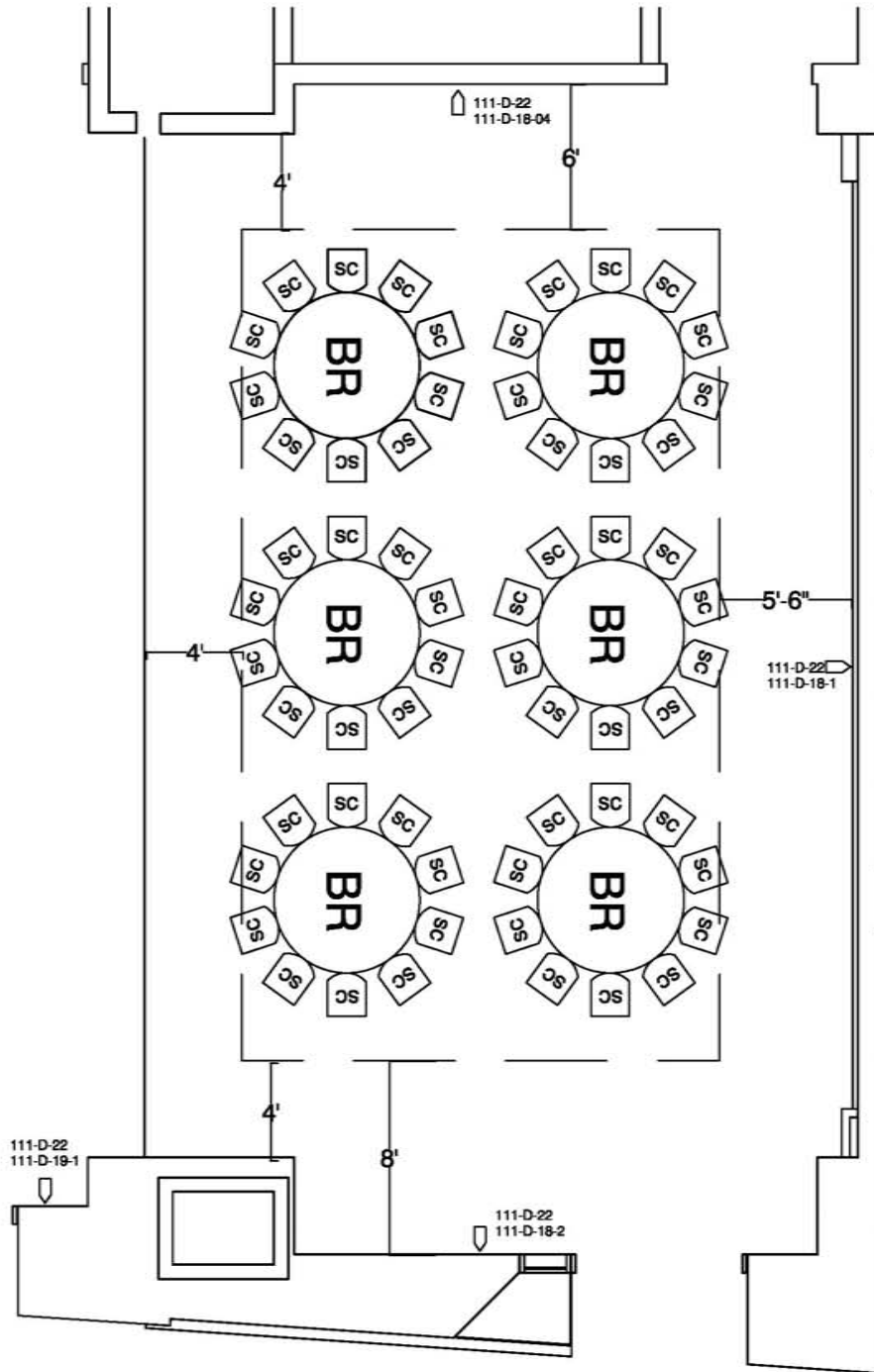

This Layout Does Not Allow Room For a Head Table  
Eliminate One Row of Tables To Place a Head Table



WASHINGTON  
CONVENTION CENTER

Meeting Room: 204 A

Banquet Capacity: 60

## LEGEND

	Stacking Chair	
	8' x 30" Table	
	8' x 18" Table	
	6' x 18" Table	
	6' x 30" Table	
	72" BANQUET ROUND TABLE	
	30" COCKTAIL ROUND TABLE	
	6'X8' MEETING ROOM RISER	
	8'X8' MEETING ROOM RISER	
	3'X3' DANCE FLOOR PANELS	
	CONGRESSIONAL LECTERN STANDARD	
	STATESMAN LECTERN (VIP)	
	CONGRESSIONAL LECTERN (ADA)	
	CONGRESSIONAL LECTERN (TABLE-TOP)	
	ADA LIFT	
	ADA RAMP	
	STEP UNIT (2)	
	STEP UNIT (3)	
	STEP UNIT (5)	
	TELEPHONE	
	FIRE EXIT	

Drawing as of 6/24/06

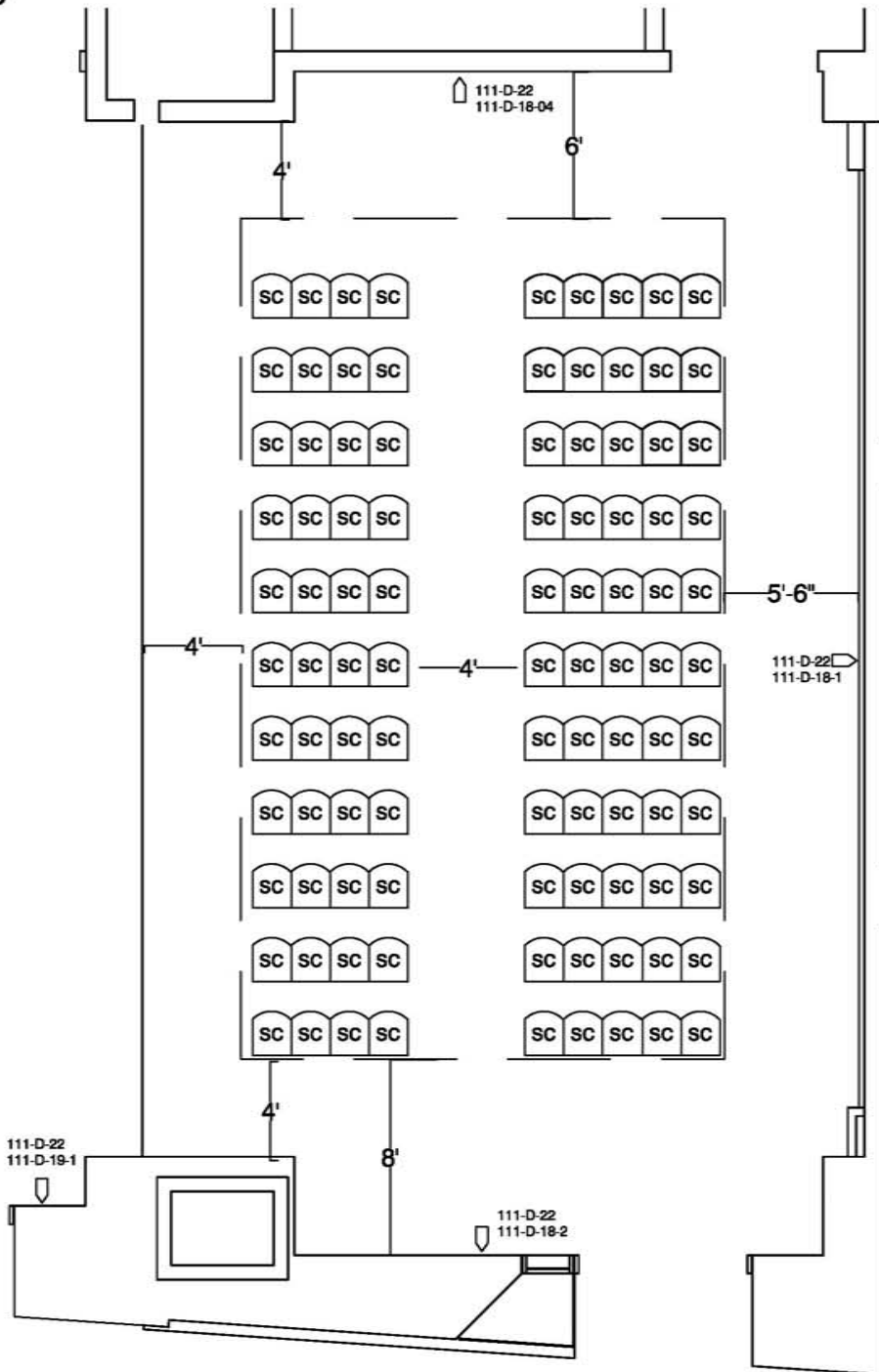

This Layout Does Not Allow Room For a Head Table  
Eliminate One Row of Tables To Place a Head Table



WASHINGTON  
CONVENTION CENTER

Meeting Room: 204 A

Theater Capacity: 99

## LEGEND

SC	Stacking Chair	
8X30	8' x 30" Table	
8X18	8' x 18" Table	
6X18	6' x 18" Table	
6x30	6' x 30" Table	
BR	72" BANQUET ROUND TABLE	
CR	30" COCKTAIL ROUND TABLE	
6X8 RISER	6'X8' MEETING ROOM RISER	
8X8 RISER	8'X8' MEETING ROOM RISER	
DF	3'X3' DANCE FLOOR PANELS	
CL-S	CONGRESSIONAL LECTERN STANDARD	
SL-VIP	STATESMAN LECTERN (VIP)	
CL-ADA	CONGRESSIONAL LECTERN (ADA)	
CL-TT	CONGRESSIONAL LECTERN (TABLE-TOP)	
LIFT	ADA LIFT	
RAMP	ADA RAMP	
STEP UNIT (2)	STEP UNIT (2)	
STEP UNIT (3)	STEP UNIT (3)	
STEP UNIT (5)	STEP UNIT (5)	
TELEPHONE	TELEPHONE	
FIRE EXIT	FIRE EXIT	





Meeting Room: 204 A  
 Classroom Capacity: 42

### LEGEND

	Stacking Chair	
	8' x 30" Table	
	8' x 18" Table	
	6' x 18" Table	
	6' x 30" Table	
	72" BANQUET ROUND TABLE	
	30" COCKTAIL ROUND TABLE	
	6'X8' MEETING ROOM RISER	
	8'X8' MEETING ROOM RISER	
	3'X3' DANCE FLOOR PANELS	
	CONGRESSIONAL LECTERN STANDARD	
	STATESMAN LECTERN (VIP)	
	CONGRESSIONAL LECTERN (ADA)	
	CONGRESSIONAL LECTERN (TABLE-TOP)	
	ADA LIFT	
	ADA RAMP	
	STEP UNIT (2)	
	STEP UNIT (3)	
	STEP UNIT (5)	
	TELEPHONE	
	FIRE EXIT	

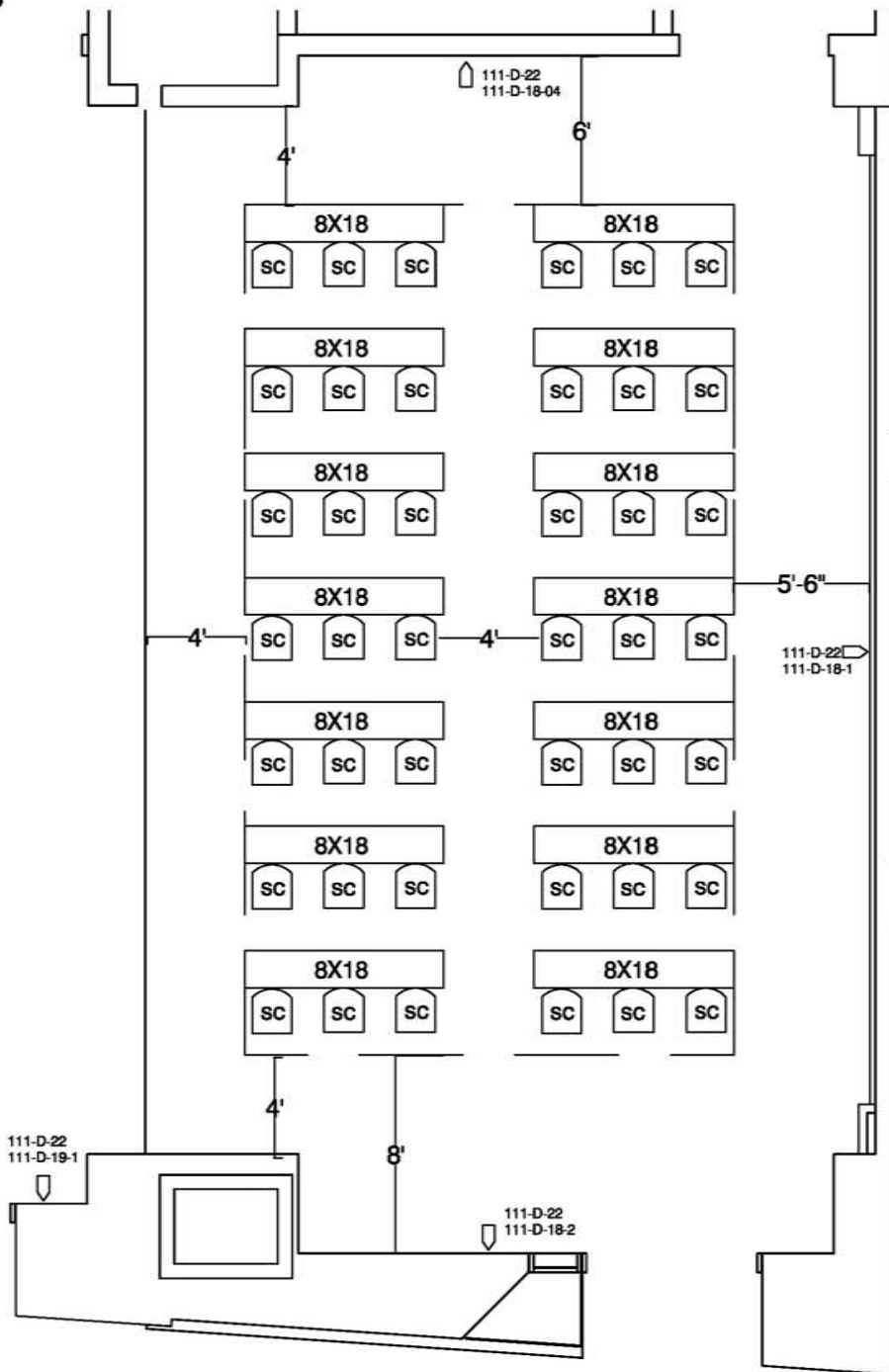

This Layout Does Not Allow Room For a Head Table  
 Eliminate One Row of Tables To Place a Head Table

Drawing as of 6/24/06

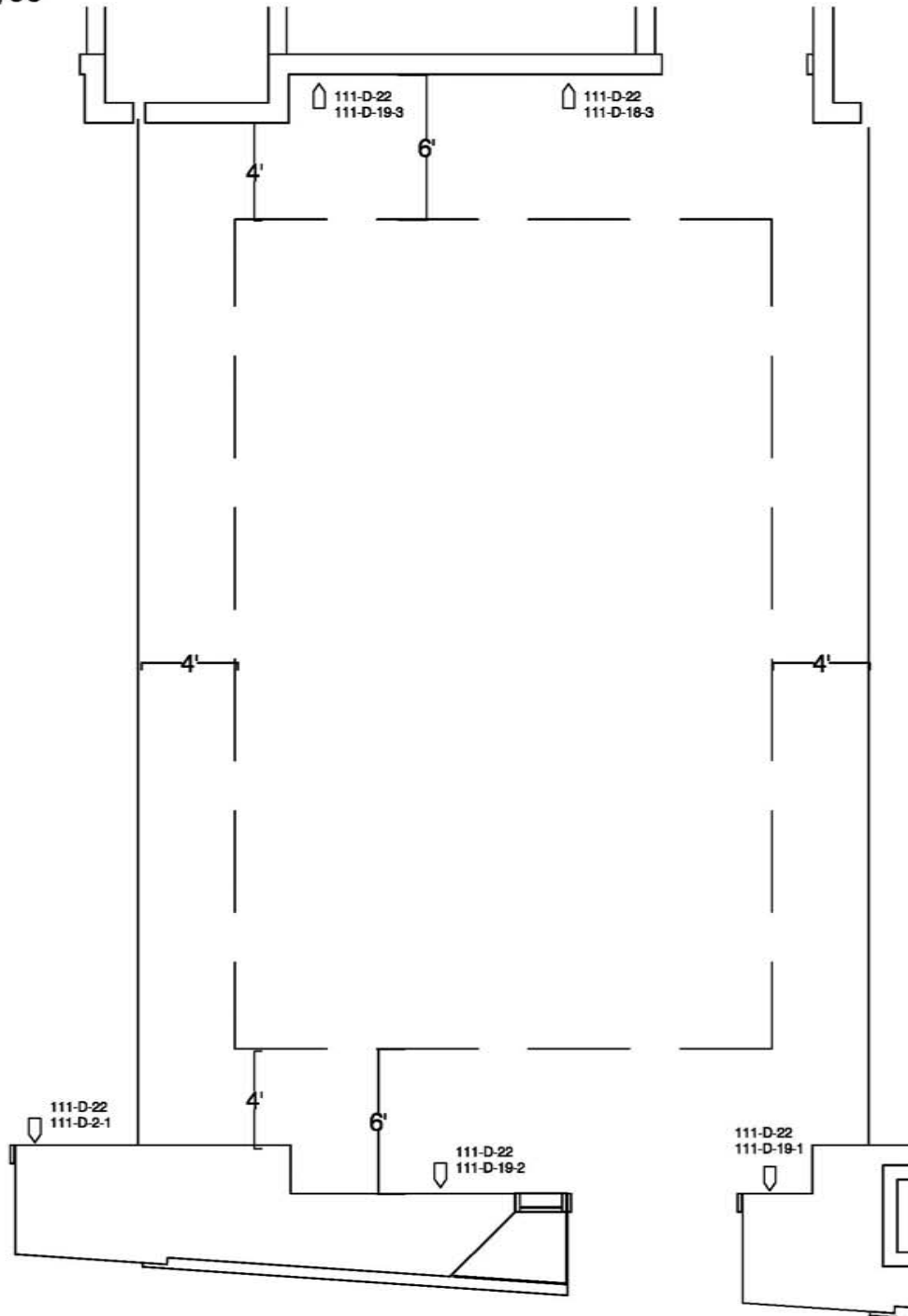

This Layout Does Not Allow Room For a Head Table  
Eliminate One Row of Tables To Place a Head Table



WASHINGTON  
CONVENTION CENTER

Meeting Room: 204 B

## LEGEND

	Stacking Chair	
	8' x 30" Table	
	8' x 18" Table	
	6' x 18" Table	
	6' x 30" Table	
	72" BANQUET ROUND TABLE	
	30" COCKTAIL ROUND TABLE	
	6'X8' MEETING ROOM RISER	
	8'X8' MEETING ROOM RISER	
	3'X3' DANCE FLOOR PANELS	
	CONGRESSIONAL LECTERN STANDARD	
	STATESMAN LECTERN (VIP)	
	CONGRESSIONAL LECTERN (ADA)	
	CONGRESSIONAL LECTERN (TABLE-TOP)	
	ADA LIFT	
	ADA RAMP	
	STEP UNIT (2)	
	STEP UNIT (3)	
	STEP UNIT (5)	
	TELEPHONE	
	FIRE EXIT	

Drawing as of 6/24/06

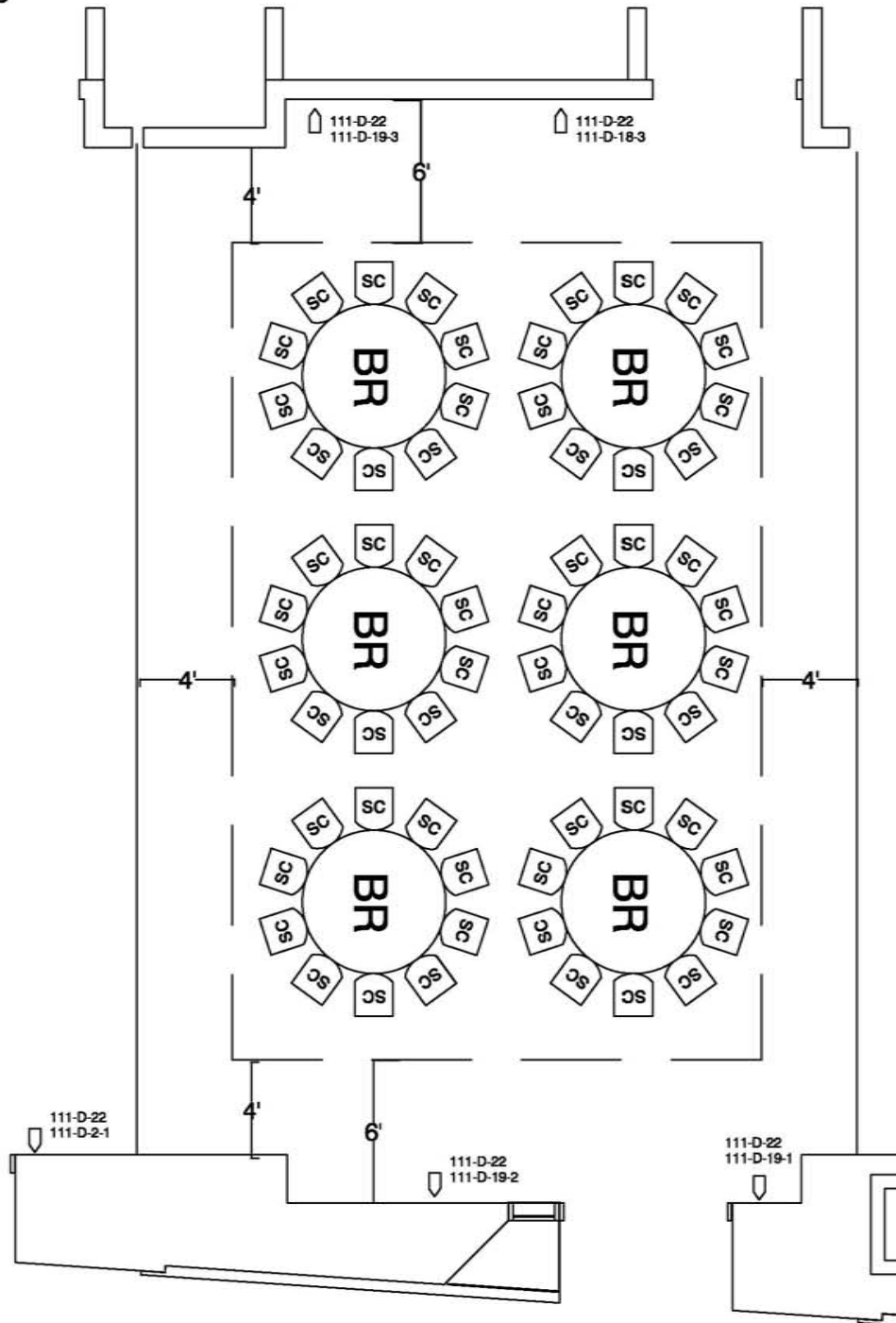

This Layout Does Not Allow Room For a Head Table  
Eliminate One Row of Tables To Place a Head Table



WASHINGTON  
CONVENTION CENTER

Meeting Room: 204 B

Banquet Capacity: 60

## LEGEND

	Stacking Chair	
	8' x 30" Table	
	8' x 18" Table	
	6' x 18" Table	
	6' x 30" Table	
	72" BANQUET ROUND TABLE	
	30" COCKTAIL ROUND TABLE	
	6'X8' MEETING ROOM RISER	
	8'X8' MEETING ROOM RISER	
	3'X3' DANCE FLOOR PANELS	
	CONGRESSIONAL LECTERN STANDARD	
	STATESMAN LECTERN (VIP)	
	CONGRESSIONAL LECTERN (ADA)	
	CONGRESSIONAL LECTERN (TABLE-TOP)	
	ADA LIFT	
	ADA RAMP	
	STEP UNIT (2)	
	STEP UNIT (3)	
	STEP UNIT (5)	
	TELEPHONE	
	FIRE EXIT	

Drawing as of 10/25/05

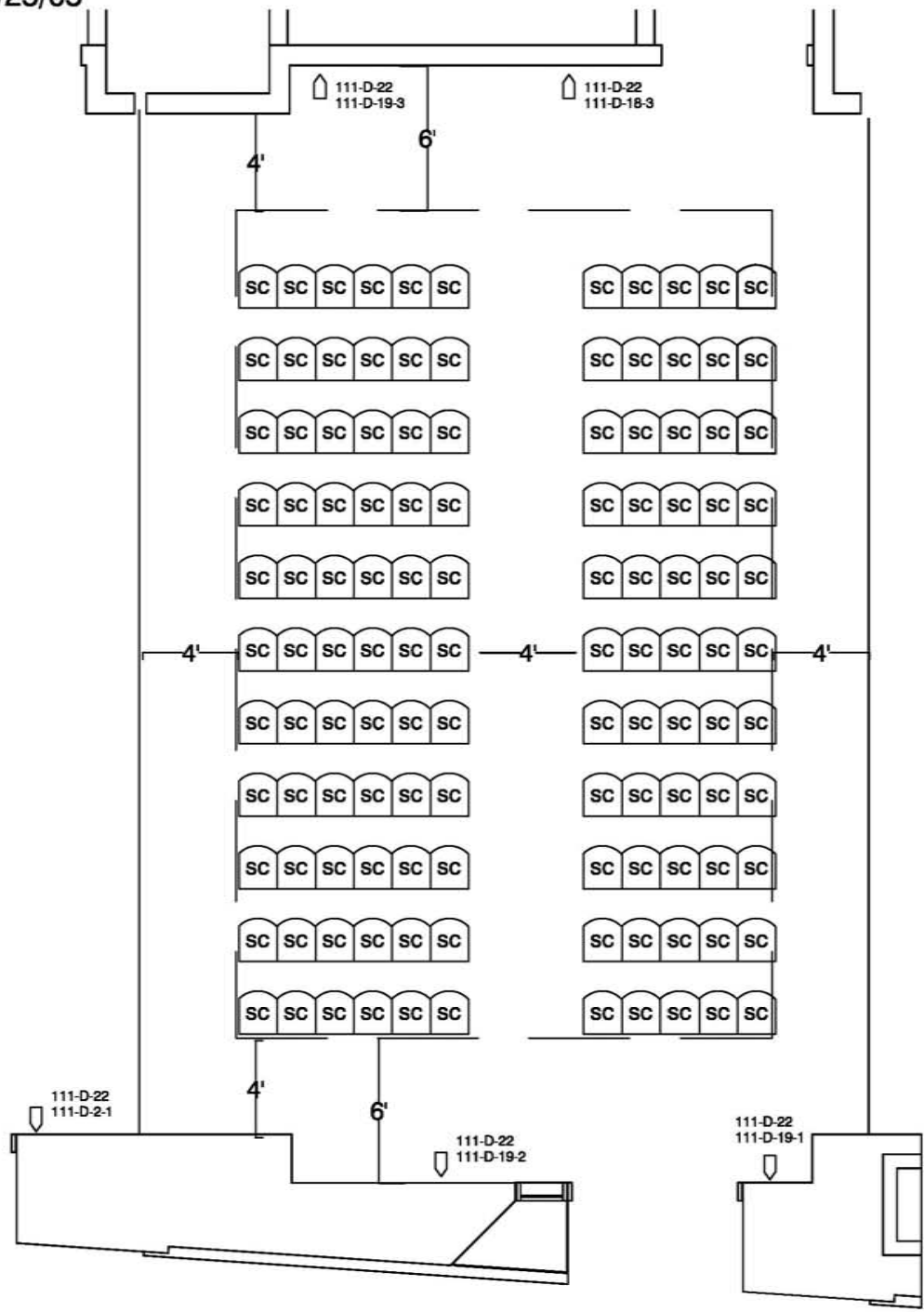

This Layout Does Not Allow Room For a Head Table  
Eliminate One Row of Tables To Place a Head Table



WASHINGTON CONVENTION CENTER

Meeting Room: 204 B  
Theater Capacity: 121

### LEGEND

	Stacking Chair	
	8' x 30" Table	
	8' x 18" Table	
	6' x 18" Table	
	6' x 30" Table	
	72" BANQUET ROUND TABLE	
	30" COCKTAIL ROUND TABLE	
	6'X8' MEETING ROOM RISER	
	8'X8' MEETING ROOM RISER	
	3'X3' DANCE FLOOR PANELS	
	CONGRESSIONAL LECTERN STANDARD	
	STATESMAN LECTERN (VIP)	
	CONGRESSIONAL LECTERN (ADA)	
	CONGRESSIONAL LECTERN (TABLE-TOP)	
	ADA LIFT	
	ADA RAMP	
	STEP UNIT (2)	
	STEP UNIT (3)	
	STEP UNIT (5)	
	TELEPHONE	
	FIRE EXIT	

Drawing as of 6/24/06

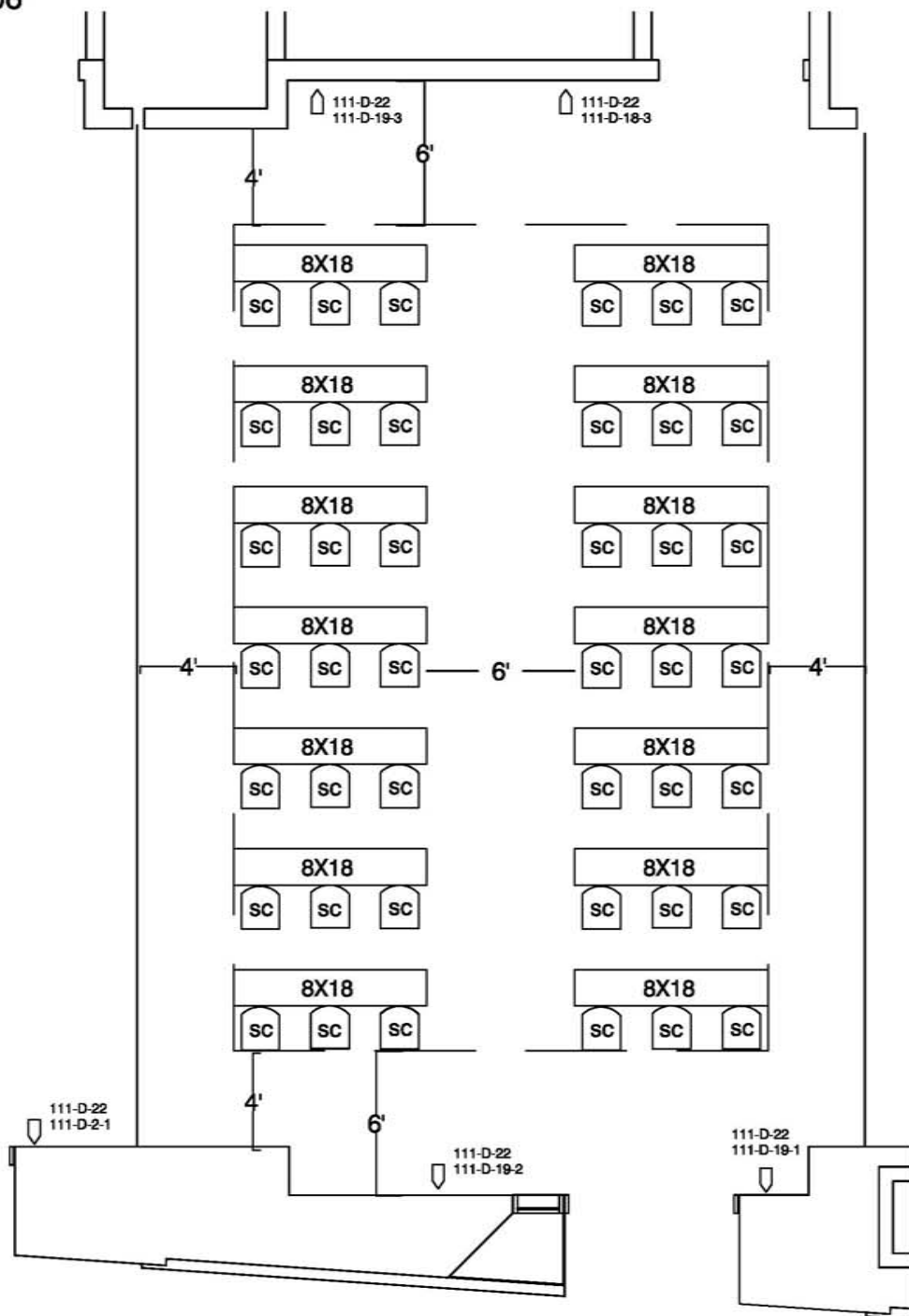

This Layout Does Not Allow Room For a Head Table  
Eliminate One Row of Tables To Place a Head Table



WASHINGTON  
CONVENTION CENTER

Meeting Room: 204 B  
Classroom Capacity: 42

## LEGEND

	Stacking Chair	
	8' x 30" Table	
	8' x 18" Table	
	6' x 18" Table	
	6' x 30" Table	
	72" BANQUET ROUND TABLE	
	30" COCKTAIL ROUND TABLE	
	6'X8' MEETING ROOM RISER	
	8'X8' MEETING ROOM RISER	
	3'X3' DANCE FLOOR PANELS	
	CONGRESSIONAL LECTERN STANDARD	
	STATESMAN LECTERN (VIP)	
	CONGRESSIONAL LECTERN (ADA)	
	CONGRESSIONAL LECTERN (TABLE-TOP)	
	ADA LIFT	
	ADA RAMP	
	STEP UNIT (2)	
	STEP UNIT (3)	
	STEP UNIT (5)	
	TELEPHONE	
	FIRE EXIT	

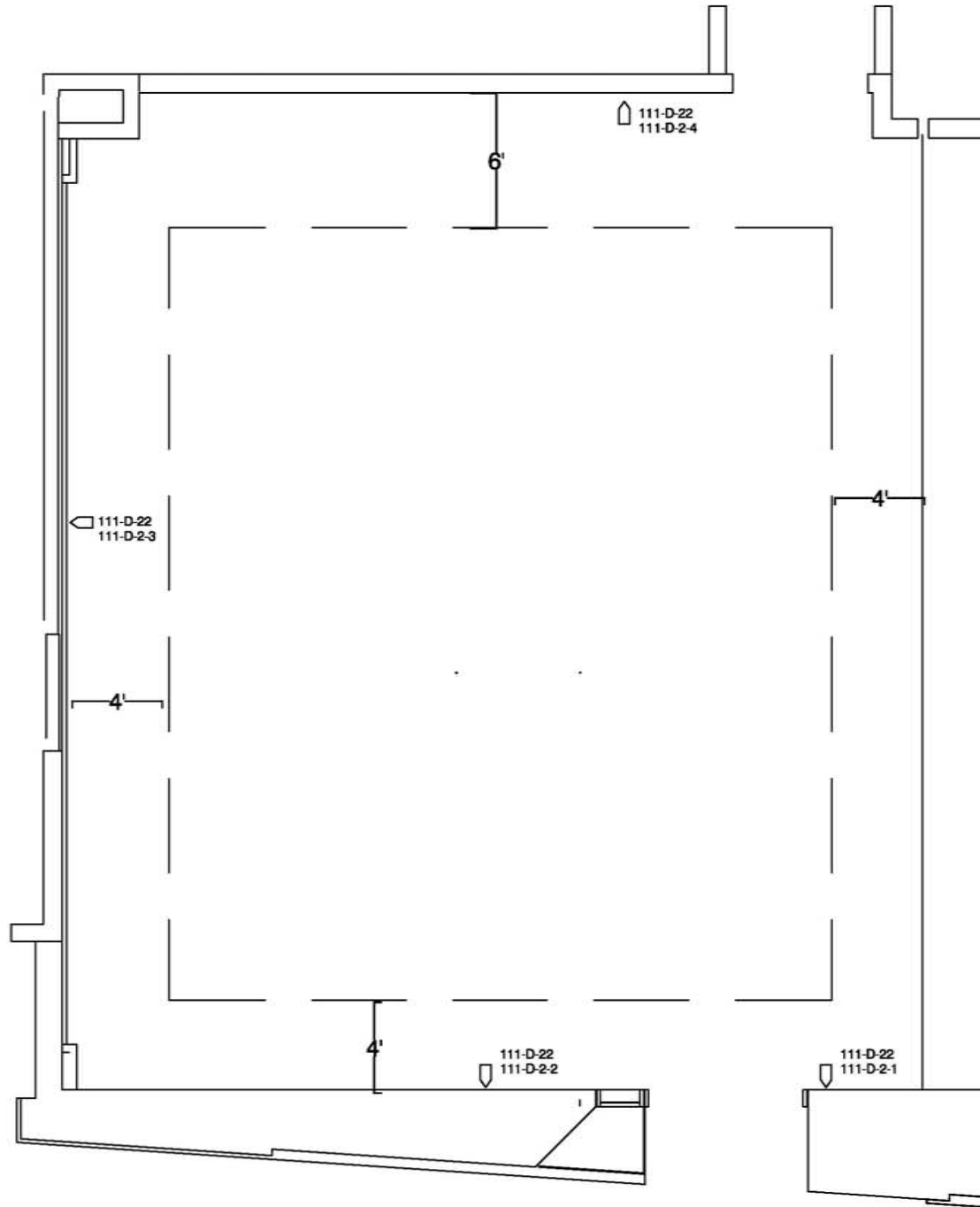

This Layout Does Not Allow Room For a Head Table  
Eliminate One Row of Tables To Place a Head Table



WASHINGTON  
CONVENTION CENTER

Meeting Room: 204 C

## LEGEND

	Stacking Chair	
	8' x 30" Table	
	8' x 18" Table	
	6' x 18" Table	
	6' x 30" Table	
	72" BANQUET ROUND TABLE	
	30" COCKTAIL ROUND TABLE	
	6'X8' MEETING ROOM RISER	
	8'X8' MEETING ROOM RISER	
	3'X3' DANCE FLOOR PANELS	
	CONGRESSIONAL LECTERN STANDARD	
	STATESMAN LECTERN (VIP)	
	CONGRESSIONAL LECTERN (ADA)	
	CONGRESSIONAL LECTERN (TABLE-TOP)	
	ADA LIFT	
	ADA RAMP	
	STEP UNIT (2)	
	STEP UNIT (3)	
	STEP UNIT (5)	
	TELEPHONE	
	FIRE EXIT	

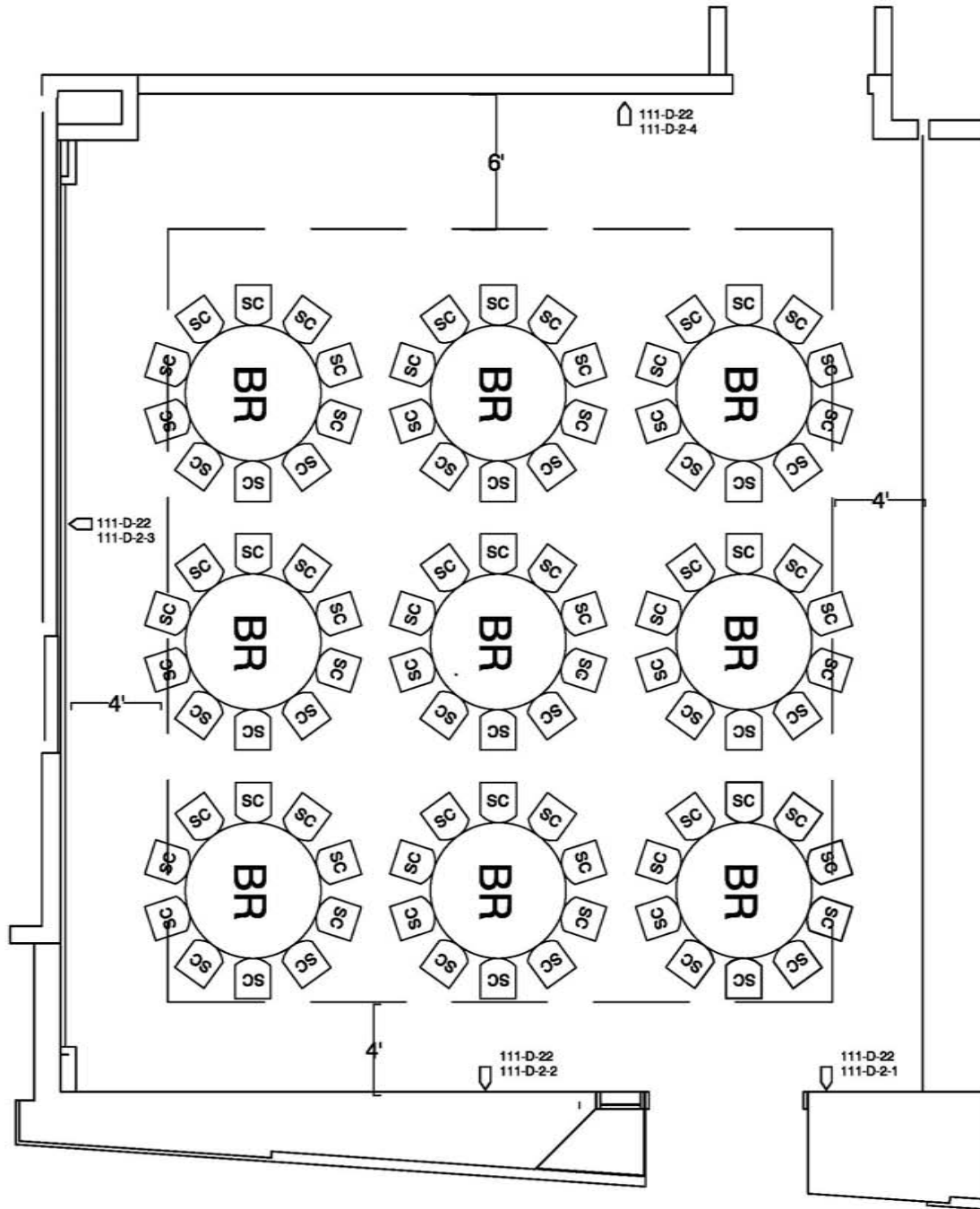

This Layout Does Not Allow Room For a Head Table  
Eliminate One Row of Tables To Place a Head Table



WASHINGTON  
CONVENTION CENTER

Meeting Room: 204 C

Banquet Capacity: 90

## LEGEND

	Stacking Chair	
	8' x 30" Table	
	8' x 18" Table	
	6' x 18" Table	
	6' x 30" Table	
	72" BANQUET ROUND TABLE	
	30" COCKTAIL ROUND TABLE	
	6'X8' MEETING ROOM RISER	
	8'X8' MEETING ROOM RISER	
	3'X3' DANCE FLOOR PANELS	
	CONGRESSIONAL LECTERN STANDARD	
	STATESMAN LECTERN (VIP)	
	CONGRESSIONAL LECTERN (ADA)	
	CONGRESSIONAL LECTERN (TABLE-TOP)	
	ADA LIFT	
	ADA RAMP	
	STEP UNIT (2)	
	STEP UNIT (3)	
	STEP UNIT (5)	
	TELEPHONE	
	FIRE EXIT	

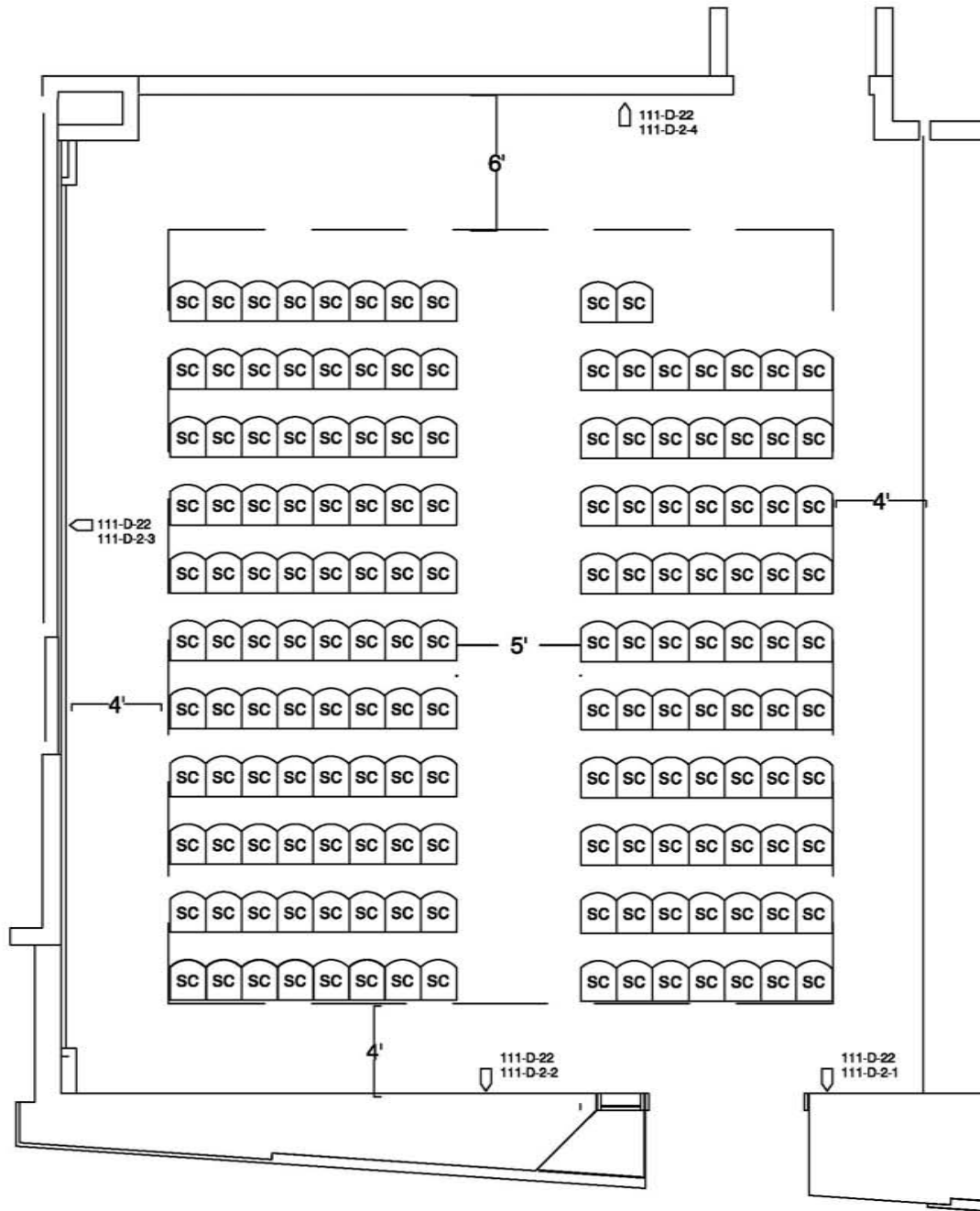

This Layout Does Not Allow Room For a Head Table  
Eliminate One Row of Tables To Place a Head Table



WASHINGTON  
CONVENTION CENTER

Meeting Room: 204 C

Theater Capacity: 160

## LEGEND

	Stacking Chair	
	8' x 30" Table	
	8' x 18" Table	
	6' x 18" Table	
	6' x 30" Table	
	72" BANQUET ROUND TABLE	
	30" COCKTAIL ROUND TABLE	
	6'X8' MEETING ROOM RISER	
	8'X8' MEETING ROOM RISER	
	3'X3' DANCE FLOOR PANELS	
	CONGRESSIONAL LECTERN STANDARD	
	STATESMAN LECTERN (VIP)	
	CONGRESSIONAL LECTERN (ADA)	
	CONGRESSIONAL LECTERN (TABLE-TOP)	
	ADA LIFT	
	ADA RAMP	
	STEP UNIT (2)	
	STEP UNIT (3)	
	STEP UNIT (5)	
	TELEPHONE	
	FIRE EXIT	



Drawing as of 6/24/06

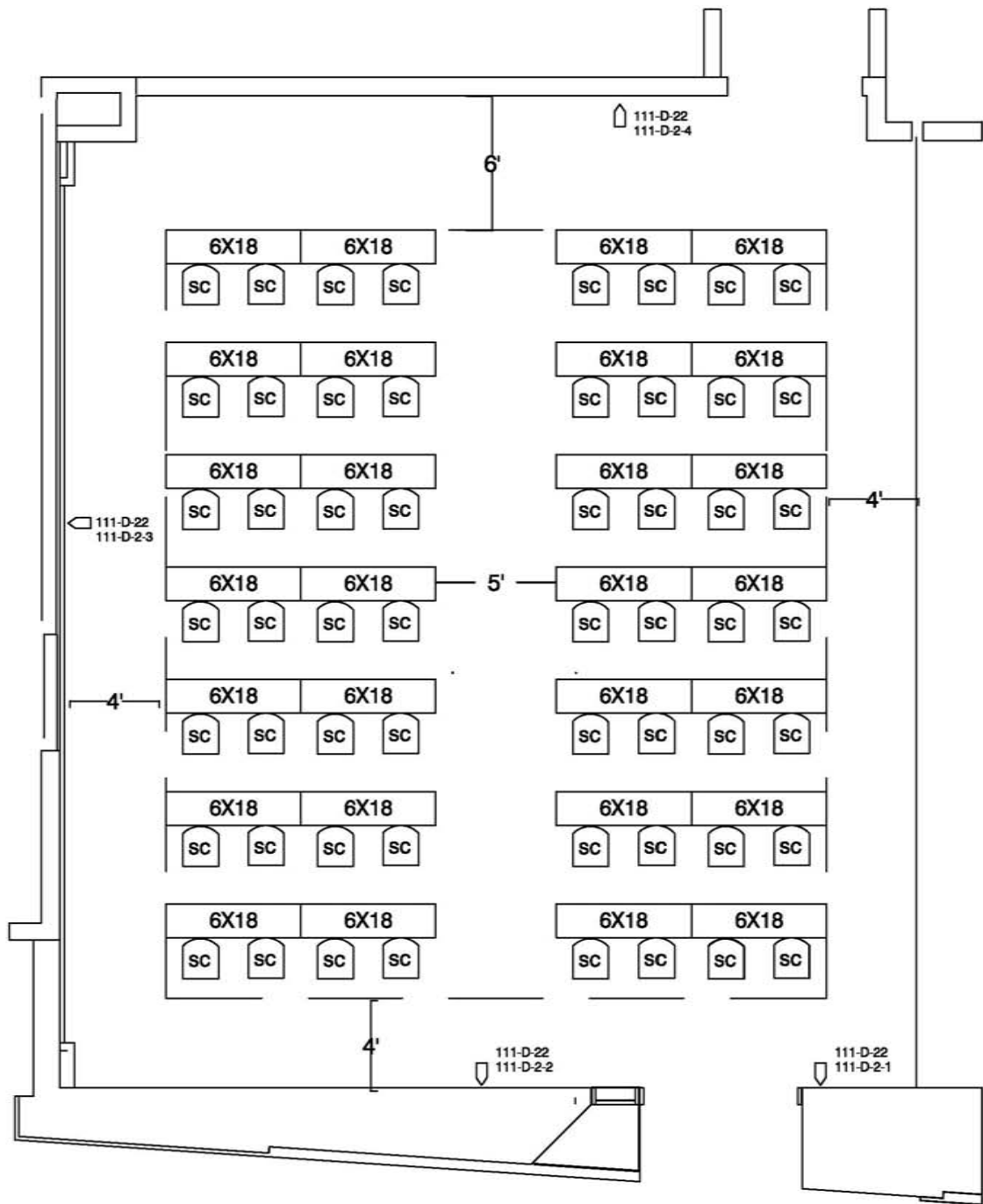

This Layout Does Not Allow Room For a Head Table  
Eliminate One Row of Tables To Place a Head Table



WASHINGTON  
CONVENTION CENTER

Meeting Room: 204 C  
Classroom Capacity: 56

## LEGEND

	Stacking Chair	
	8' x 30" Table	
	8' x 18" Table	
	6' x 18" Table	
	6' x 30" Table	
	72" BANQUET ROUND TABLE	
	30" COCKTAIL ROUND TABLE	
	6'X8' MEETING ROOM RISER	
	8'X8' MEETING ROOM RISER	
	3'X3' DANCE FLOOR PANELS	
	CONGRESSIONAL LECTERN STANDARD	
	STATESMAN LECTERN (VIP)	
	CONGRESSIONAL LECTERN (ADA)	
	CONGRESSIONAL LECTERN (TABLE-TOP)	
	ADA LIFT	
	ADA RAMP	
	STEP UNIT (2)	
	STEP UNIT (3)	
	STEP UNIT (5)	
	TELEPHONE	
	FIRE EXIT	